



Unicla



**UX330
Compressor
Service Manual**

UX330 Compressor Service Manual

Table of contents:

1. Specifications

| | |
|-----------------------|---|
| UX330 | 1 |
| Magnetic clutch | 2 |

2. Component part list

| | |
|----------------------------------|---|
| I. Compressor part numbers | 3 |
| II. Exploded view | 4 |

3. Service

| | |
|---|----|
| Service tools part numbers | 5 |
| Bolt torque specifications | 5 |
| Service tools | 6 |
| Disassembly and reassembly procedures | 7 |
| Magnetic clutch installation | 8 |
| Removal of lip seal | 9 |
| Installation of lip seal | 9 |
| Installation of lip seal continued | 10 |
| Disassembly of the body..... | 10 |
| Assembly of the body..... | 11 |
| Assembly of the body continued | 12 |
| System oil quantity | 13 |
| Oil type and grade | 13 |



Copyright ©2007 All rights reserved

No part of this document shall be reproduced in whole or in part without the permission of Unicla International Ltd. This includes reproduction or copies in any form or by any means including photocopying, printing or electronic media.

IMPORTANT DISCLAIMER

This is a guideline document containing professional information using representative graphs, charts and tables. Manufacturers' specifications must be consulted for specific guidelines and performance data. Unicla published data, specific to all models, is available in promotional literature and from Unicla International Ltd on request or through your Unicla supplier. Unicla International Ltd expressly disclaims all and any liability and responsibility to any person or business as a result of any actions taken on the basis of information in this publication.

Compressor UX330

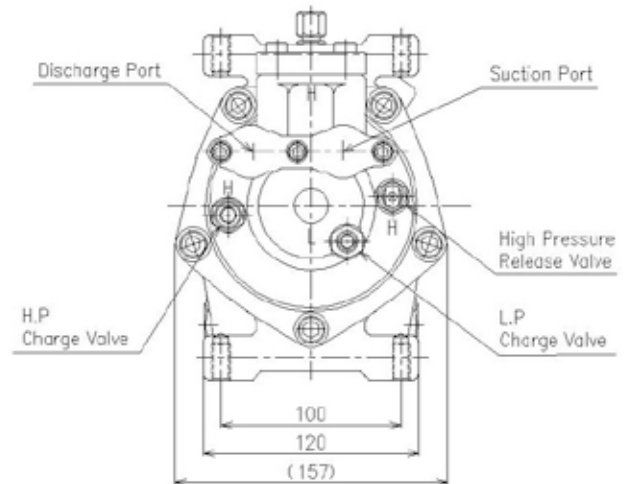
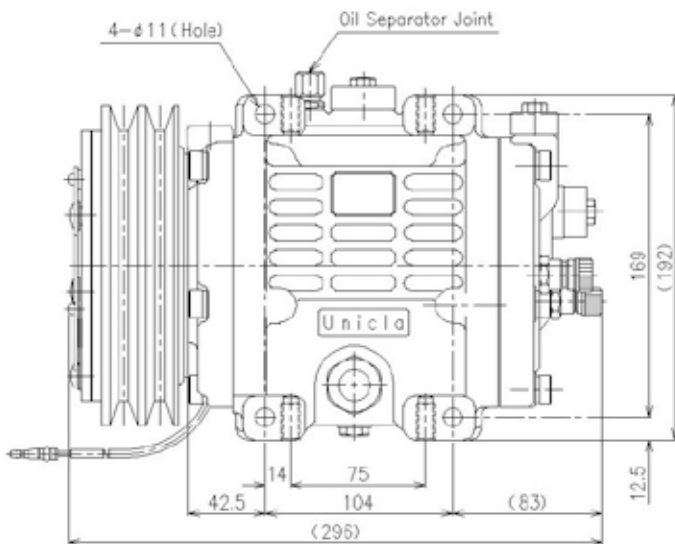
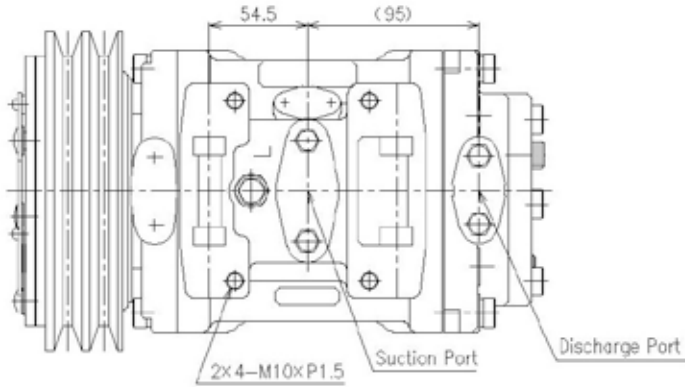

| Compressor Model | UX-330 |
|--------------------------|---------------|
| Number of cylinders | 10 |
| Displacement | 330 cc/rev |
| Refrigerant | HFC-134a |
| Maximum continuous speed | 4500 rpm |
| Initial oil charge | 600 cc |
| Oil type | PAG or POE |
| Voltage | DC 12/24 volt |
| Weight without clutch | 11.5 kg |

Magnetic clutches

Diameter $\phi 168$

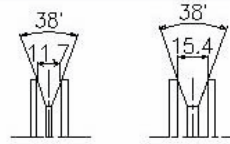
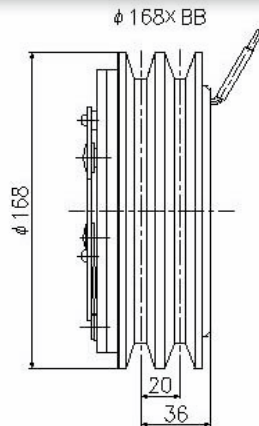
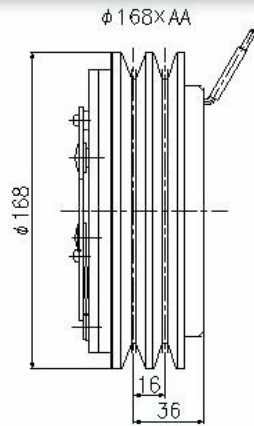

A type ditch B type ditch

| Type | Part NO. | Volt |
|------|--------------|------|
| AA | 27201-00480 | 12 |
| AA | 27201-00290 | 24 |
| BB | 27205-000030 | 12 |
| BB | 27201-00510 | 24 |

Diameter $\phi 178$

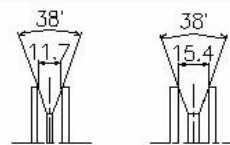
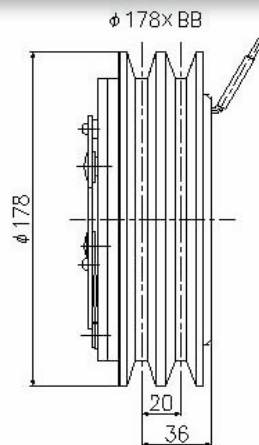
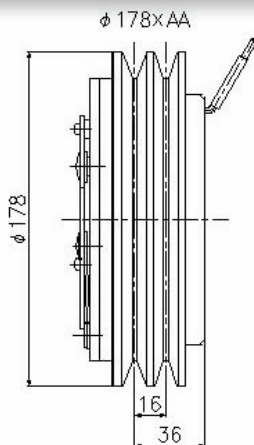

A type ditch B type ditch

| Type | Part NO. | Volt |
|------|--------------|------|
| AA | 27205-000220 | 12 |
| AA | 27205-000190 | 24 |
| BB | 27205-000230 | 12 |
| BB | 27205-000130 | 24 |

Diameter $\phi 168$

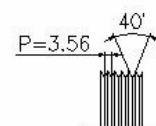
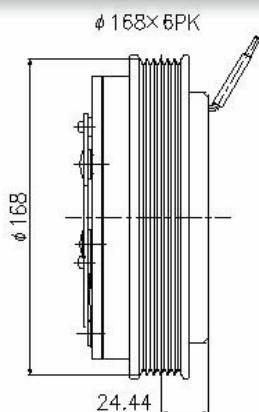
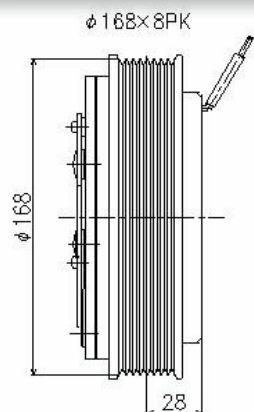

Multi type ditch

| Type | Part NO. | Volt |
|------|--------------|------|
| 8PK | 27201-01210 | 12 |
| 8PK | 27201-01140 | 24 |
| 6PK | 27205-000460 | 24 |

Compressor parts

| No. | Description | Part number | Qty |
|-----|----------------------|--------------|-----|
| 1 | Body | 21405-000740 | 1 |
| 2 | Front cap | 21510-000012 | 1 |
| 3 | Working assembly | 22010-000430 | 1 |
| 4 | Suction valve | 22602-000010 | 2 |
| 5 | Valve plate assembly | 22601-000010 | 2 |
| 6 | Gasket | 93204-000030 | 2 |
| 7 | Rear cap | 21505-000260 | 1 |
| 8 | Sight glass | 35801-000010 | 2 |
| 9 | Nipple | 42203-000161 | 1 |
| 10 | Relief valve | 38305-000030 | 1 |
| 11 | Plug | 13201-000010 | 2 |
| 12 | Lip seal assembly | 92503-000050 | 1 |
| 13 | Felt | 11950-11000 | 1 |
| 14 | Charge valve (H) | 38101-000030 | 1 |
| 15 | Charge valve (L) | 38101-000020 | 1 |
| 16 | O-ring (S115) | 92501-00190 | 2 |
| 17 | O-ring (S11.2) | 92501-000120 | 2 |
| 18 | O-ring (P22) | 92501-000070 | 3 |
| 19 | Screw (M10 x 30) | 91015-10030 | 5 |
| 20 | Screw (M10 x 35) | 91915-10035 | 5 |
| 21 | O-ring (P18) | 92501-000090 | 1 |



Exploded view

UX330

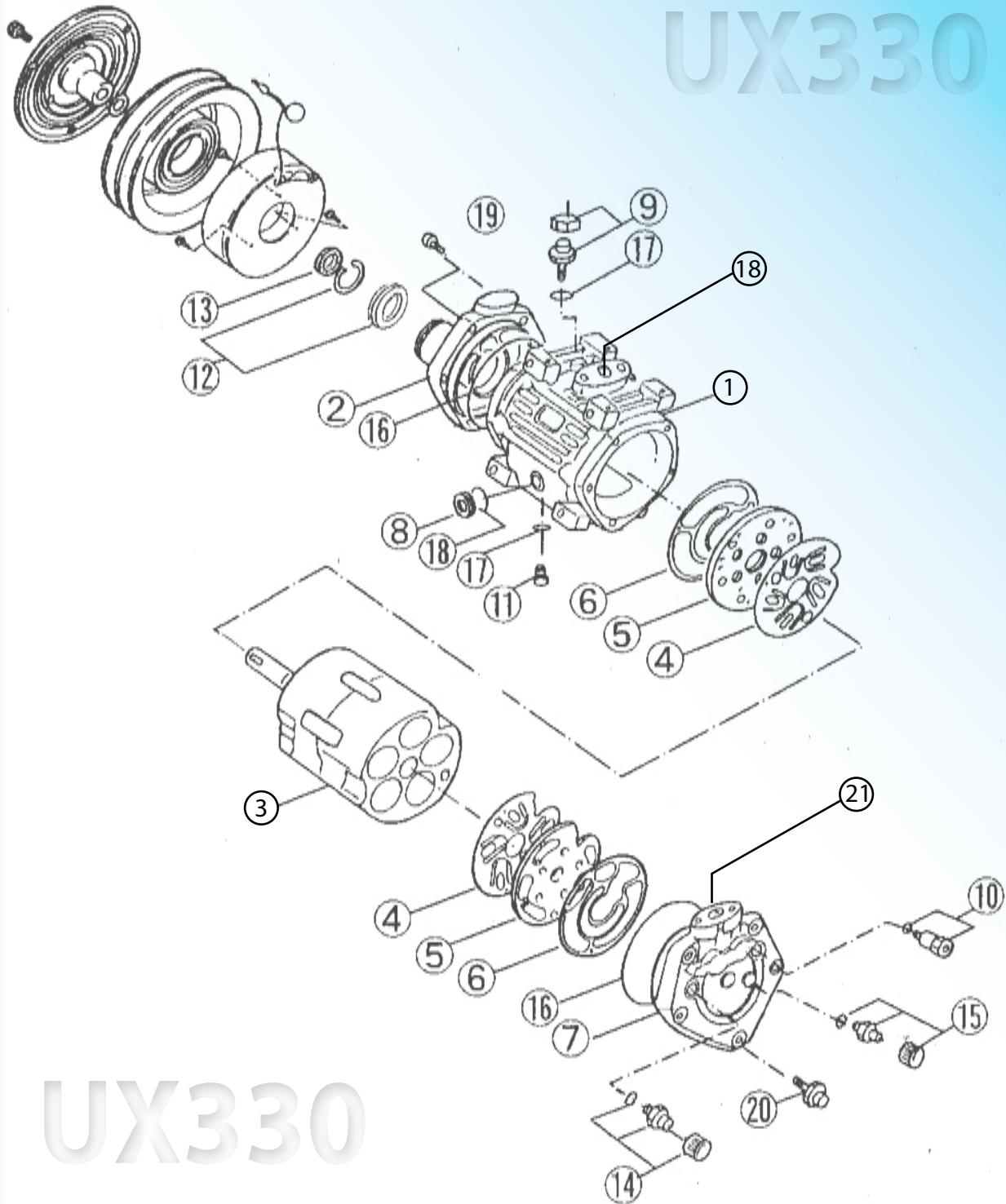

UX330

Service tool part numbers

| No. | Description | Part number |
|-----|-----------------------------------|--------------|
| 1 | Working installer | 03301-000290 |
| 2 | Stand | 03301-000310 |
| 3 | Installer ring & seal | 03301-000320 |
| 4 | Remover seal | 03301-001000 |
| 5 | Shaft rotating handle | 03301-000340 |
| 6 | Clutch wrench | 03301-000370 |
| 7 | Torque wrench | 03301-000380 |
| 8 | Installer pulley | 03301-000350 |
| 9 | Guide sleeve | 03301-000330 |
| 10 | Guide pin | 03301-000490 |
| 11 | Armature Remover | 03301-010010 |
| 12 | Pulley remover pad | 03301-012370 |
| 13 | Pulley remover | 03301-000410 |
| 14 | Thickness guage | 03301-000400 |
| 15 | M10 Hexagonal socket | 03301-000450 |
| 16 | M8 Socket | 03301-000440 |
| 17 | Plastic hammer | 03301-000390 |
| 18 | Snap ring pliers (<i>Shaft</i>) | 03301-000430 |
| 19 | Snap ring pliers (<i>Hole</i>) | 03301-000420 |

Bolt torque specifications

| Description | Bolt diameter (mm) | Tightening torque (N•m) |
|------------------------|--------------------|-------------------------|
| Housing cap bolts | M10 x P1.5 | 34.3 ± 1 |
| High/low service valve | M12 x P1.0 | 11.7 ± 1 |
| High/low pressure port | M8 x P1.25 | 24.5 ± 1 |
| Clutch coil bolts | M6 x P1.0 | 5.9 ± 1 |
| Clutch armature bolts | M8 x P1.25 | 19.6 ± 1 |

Service tools

 - Genuine Unicla tools

 - Optional generic tools

1 03301-000290

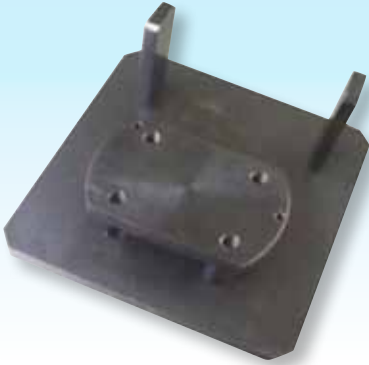

2 03301-000310



3 03301-000320



4 03301-001000



5 03301-000340



6 03301-000370

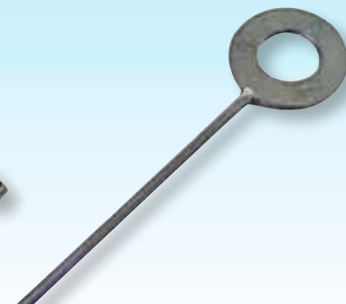

7 03301-000380

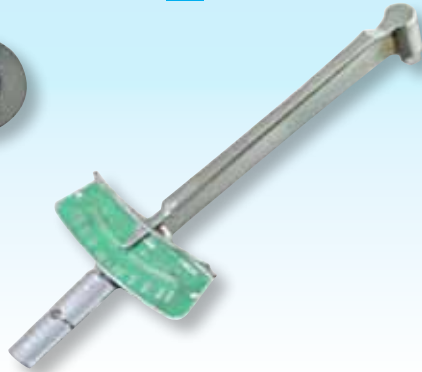

8 03301-000350



9 03301-000330



10 03301-000490



11 03301-010010



13 03301-000410



12 03301-012370



14 03301-000400

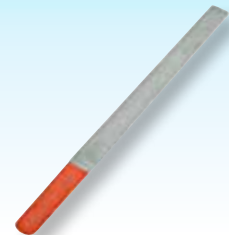

15 03301-000450



16 03301-000440



17 03301-000390



18 03301-000430



19 03301-000420

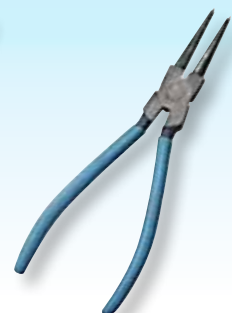

UX330 COMPRESSOR SERVICE MANUAL

Disassembly & reassembly procedure

I. Removal of magnetic clutch

Tools required: • Stand • Clutch wrench
• Torque wrench • M8 Socket

Procedure: Place the compressor on the stand. Hold clutch wrench by inserting the claws of the clutch wrench into the holes on the armature (3 points). Remove the centre bolt by using the torque wrench. Pull the armature upwards

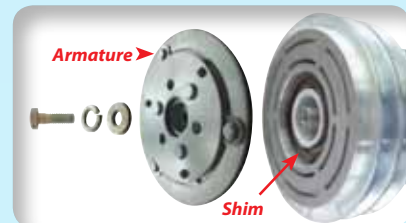
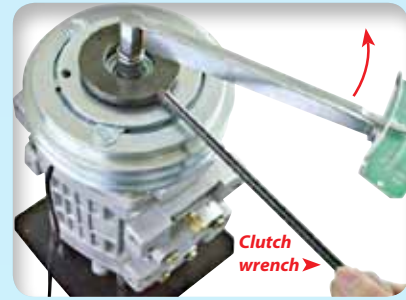

II. Removal of snap ring

Tools required: • Snap ring pliers (shaft)

Procedure: Remove the snap ring by the snap ring pliers as shown



III. Removal of pulley

Tools required: • Pulley remover • Standard wrench
• Pulley remover pad



IV. Removal of coil

Tools required: • Standard screwdriver

Procedure: Remove 3 M6 bolts with screwdriver

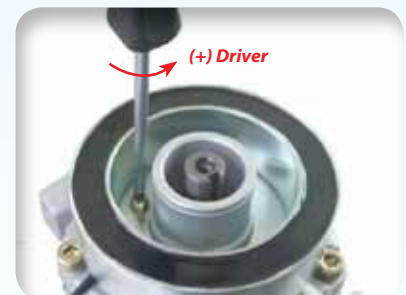

V. Inspection of magnetic clutch components

Armature - Contact surfaces must be clean, smooth and unmarked, with no abnormal scoring

Pulley - As above. Ensure bearings run smoothly

Coil - Wiring harness must be in good condition



Magnetic clutch installation

I. Installation of coil

Tools required: • Stand • Standard screwdriver

Procedure: Tighten 3 bolts (*wire must be visible at 3 o'clock position, when viewed from the front*).

Tightening torque: $5.9 \pm 1 \text{ N}\cdot\text{m}$

II. Installation of pulley

Tools required: • Pulley installer • Plastic hammer

Procedure: Place the pulley on the nose top and install it by tapping on the installer until it stops. Do not tap if the pulley is not located correctly.

III. Installation of clutch key and snap ring

Tools required: • Snap ring pliers (*shaft*)

Procedure: Install the snap ring into the groove (*tapered side up*)

IV. Installation of shims and armature

Tools required: • Guide pin

Procedure: Install the guide pin into the centre threaded hole of the shaft and select shims ($T=0.1, 0.3$ and 0.5mm) to ensure the clutch clearance as in figure.

V. Installation of armature

Tools required: • Clutch wrench • Torque wrench
• M8 Socket

Procedure: Place washers and spring washers on M8 by holding the clutch wrench on the holes (*3 positions*) on the armature. **Tightening torque:** $19.6 \pm 1 \text{ N}\cdot\text{m}$

VI. Air gap

Tools required: • Thickness gauge

Procedure: Ensure clutch clearance is correct all around. ($0.3\text{mm} \leq \text{gap} \leq 0.6\text{mm}$)

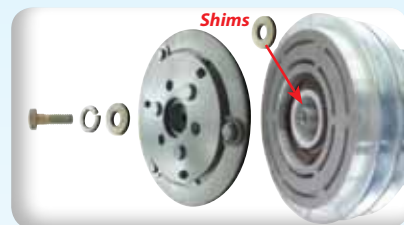
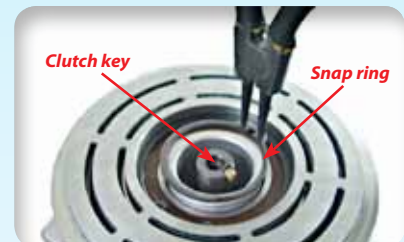
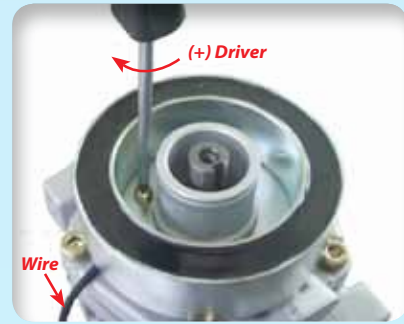

Removal of lip seal

I. Removal of the felt

Procedure: Removal of the felt on the shaft by hooking with the slender bar.

II. Removal of snap ring

Tools required: • Snap ring pliers (*hole*)

Procedure: Remove the snap ring slowly with pliers as shown in the figure.

III. Removal of lip seal

Tools required: • Lipseal remover

Procedure: Insert the lip seal into the recess as shown in the figure, turn around lightly and pull out.

IV. Inspection of lip seal

1. **Felt seal** - *should be dry.*
2. **Snap ring** - *must be in one piece and not deformed.*
3. **Lip seal.**

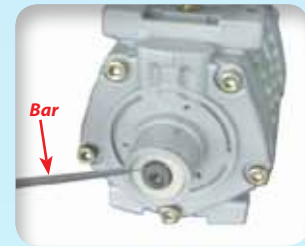

Installation of lip seal

I. Setting the guide sleeve

Tools required: • Stand • Guide sleeve

Procedure: Place compressor on the stand. Lubricate outside of the guide sleeve and insert into the shaft of the compressor.

Caution - the sleeve must be clean and unmarked.

II. Installation of lip seal

Tools required: • Guide sleeve • Lipseal installer

Procedure: Slice the lipseal over the guide sleeve. Place the remover on the lip seal correctly and press the lipseal with the remover until it stops. Then remove the guide sleeve.

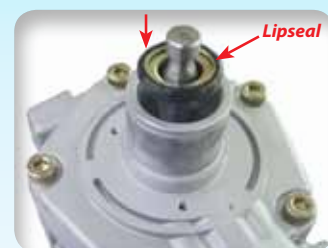

Installation of lip seal - continued

III. Assembly of the snap ring

Tools required: • Snap ring pliers (*hole*) • Installer ring

Procedure: Insert the snap ring into nose section (*tapered part of the snap ring must be facing downwards as shown in photo*). Push the snap ring downward with the remover, and fit into groove.

IV. Assembly of the felt seal

Tools required: • Installer ring

Procedure: Install the felt seal into the nose section. Push the felt seal until it touches the snap ring.



Disassembly of the body

Caution - O-ring should not be reused.

I. Removal of oil

Procedure: Remove the drain plug and drain the oil.

II. Removal of lipseal (Refer to page 9 for instructions)

III. Removal of the bolts on rear cap

Tools required: • Socket wrench (*hexagon*) 10mm • Stand

Procedure: Remove the M10 securing bolts (*5pcs*) from the rear cap.

IV. Removal of the rear cap

Procedure: Remove the rear cap by gently inserting a screw driver or lever into the recess. Lever all around, not just at one position.

Caution - Do not damage the end of front cap and body.



V. Removal of rear valve

Procedure: Remove gasket, valve plate and suction valve. Remove the working assembly by pressing the end of the shaft into the front of the body as shown.

VI. Removal of front valve and working assembly

Procedure: After removal of the cylinder, remove gasket, valve plate and suction valve from the front side.

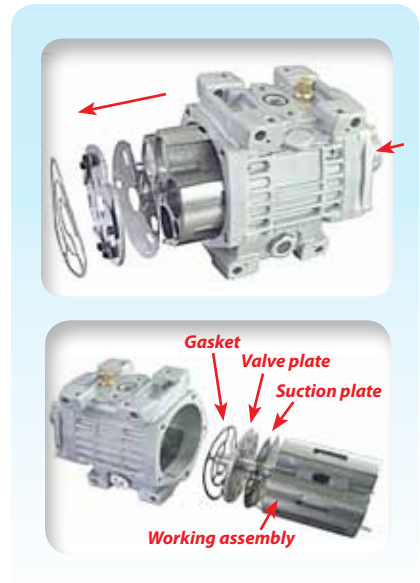

Assembly of the body

I. Installation of the O-ring for front and rear cap

Procedure: The o-ring must be free from marks and dust. Thoroughly lubricate new o-ring properly and insert into the groove. Ensure the o-ring is lying straight in the groove without a twist.

II. Installation of the front cap

Tools required: • Torque wrench

Procedure: Place the body with front section facing upward. Place the front cap on the body (*be careful not to twist the o-ring*). Tighten M10 bolts (5pcs) with torque wrench.

Tightening torque: $34.3 \pm 1 \text{ N}\cdot\text{m}$

III. Installation of the front valve plate and body

Tools required: • Working assembly bench

Procedure: Place the working assembly on locating pins. Stack the suction plate, the valve plate and gasket on locating pins in sequence as shown in the figure. Carefully lower the body over the working assembly until it stops next to the working bench guide.

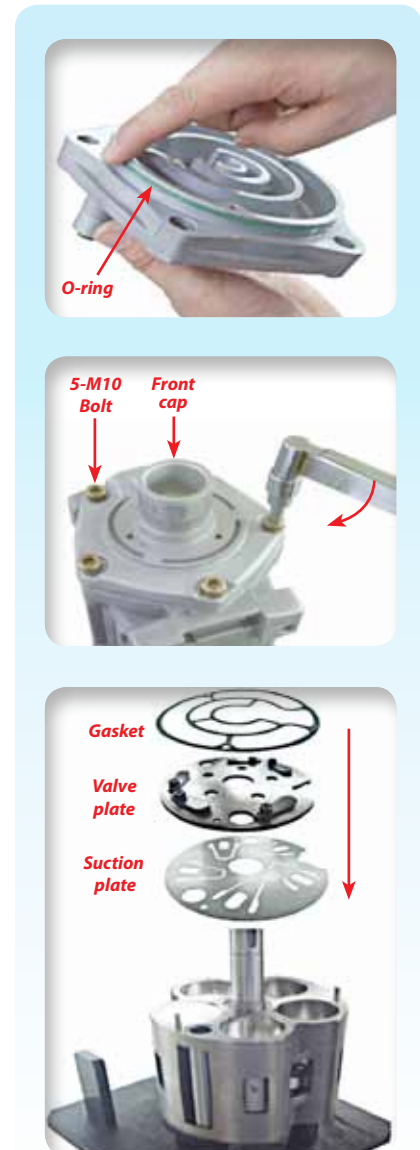

Assembly of the body - continued

IV. Installation of the rear valve plate and rear cap

Tools required: • Stand

Procedure: Place the body in an inverted position on the stand and stack the suction plate, valve plate and gasket in the figure. Thoroughly lubricate and install the o-ring into the rear cap groove. Ensure the o-ring is lying straight in the groove without any twists.

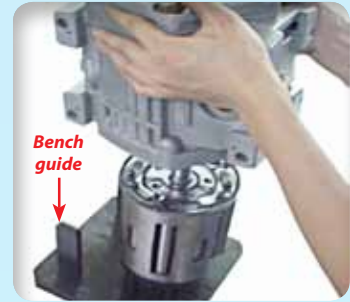

V. Inspection, tightening and clearance of the rear cap

Tools required: • Torque wrench • Hexagon socket
• Thickness gauge

Procedure: Tension the M10 Hexagonal flange bolts (5pcs) diagonally, alternately and carefully. Check the rear cap clearance as specified: $0.3 \leq \text{Gap} \leq 1.2\text{mm}$

Tightening torque: $34.3 \pm 1 \text{ N}\cdot\text{m}$



VI. Installation of lipseal (Refer to page 9 for instructions)

VII. Test working assembly rotation

Tools required: • Shaft rotating handle

Procedure: Install the handle into the front section to check the shaft rotates smoothly.



VIII. Filling compressor oil

Procedure: Fill the following amount of oil from the low pressure charge port as shown in the photo. Ensure drain correctly plugged.

Standard oil type: Unidap 7 (PAG) or Unidap 6 (POE)
Amount of oil = $600 \pm 10 \text{ cc}$



IX. Plug cap on oil port

Procedure: Tighten high/low pressure port caps with M8 bolts.

Tightening torque: $24.5 \pm 1 \text{ N}\cdot\text{m}$

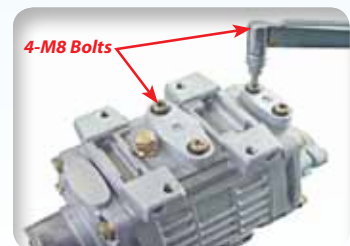

System oil quantity

The correct amount of oil must be maintained in the compressor and system. Long hose runs and dual evaporator systems must have additional oil added to the system. Severe oil starvation problems may result from insufficient system oil being allowed. To determine oil quantity required, Unicla recommends a calculation as a percentage of refrigerant charge as follows:

- **20% for Unicla UX330 compressors** in standard applications where the suction and discharge lines are less than 6 metres in length.
- **30% for Unicla UX330 compressors** in applications where suction and discharge lines exceed 6m in length.

Example:

Calculate oil charge as 20% of refrigerant charge, 5 kg charge = 5000 g x 20% = 1000 ml (cc) of oil. If fitting a UX330 compressor, then deduct the compressor initial oil charge to determine amount of oil to be added. Therefore 1000 – 600 = 400cc oil to be added to system.

Oil type and grade

Each Unicla UX330 is fitted with either PAG oil (*Unidap 7*) or POE oil (*Unidap 6*). When adding oil to the system, Unicla oil must be used. **▲Warranty is void if these guidelines are not followed.**

| Compressor Model | Refrigerant | Oil Type (Unicla) | Viscosity @ 40°C | Viscosity @ 100°C | Application | Low side Saturation | Oil Separator |
|------------------|-------------|-------------------|------------------|-------------------|-----------------|---------------------|---------------|
| UX330 | R134a | Unidap 7 | 48.01 | 10.51 | Airconditioning | > 0°C | Optional |
| UX330 | R134a | Unidap 6 | 65.5 | 9.3 | Airconditioning | >0°C | Optional |

The following labels will determine the type of oil in each UX330 compressor:



POE type



PAG type

Storage guidelines

- Evacuate compressor for 3 minutes and fill with nitrogen (N²) at 0.1 ~ 0.2 MPa.
- Place the compressor in a clean and dry area with low humidity and tag with details.
- Keep compressor away from direct sunlight.
- Store the compressor horizontally on a flat, even surface.
- Do not store the compressor in temperatures above 30°C.
- Place the compressor in a well ventilated area to avoid corrosion damage.

UX330 COMPRESSOR SERVICE MANUAL

*The contents of this manual are subject to change without prior notice.



Unicla International Limited
Unit 1109, 11F Manhattan Centre,
8 Kwai Cheong Rd, Kwai Chung, N.T.,
Hong Kong

Phone (852) 2422 0180
Fax (852) 2422 0680
Email: sales@unicla.hk
Website: www.unicla.hk