



**Burgaflex**



**BURGA CLIP<sup>®</sup>**  
**CATALOGUE**

**PREMIUM FLEXIBLE REFRIGERANT HOSE SOLUTION**  
*For automotive, transport and stationary  
air-conditioning and refrigeration applications*

# BURGACLIP® - Assembly Instructions

The most reliable, durable, fastest and extensive flexible refrigerant hose solution for the automotive, transport and stationary air-conditioning and refrigeration industry.



- BURGACLIP® hose fitting technology delivers a superior connection solution for multiple refrigerants such as R134a, R404a, R410a, R457a, R513a, HFO1234yf/yz and many other low-temperature refrigerants.
- 75% less permeation and moisture ingress than assembly solutions presently available on the market
- Quick assembly of hose fittings with the breakthrough BURGACLIP® technology
- Manufactured to meet the stringent TS 16949 certification

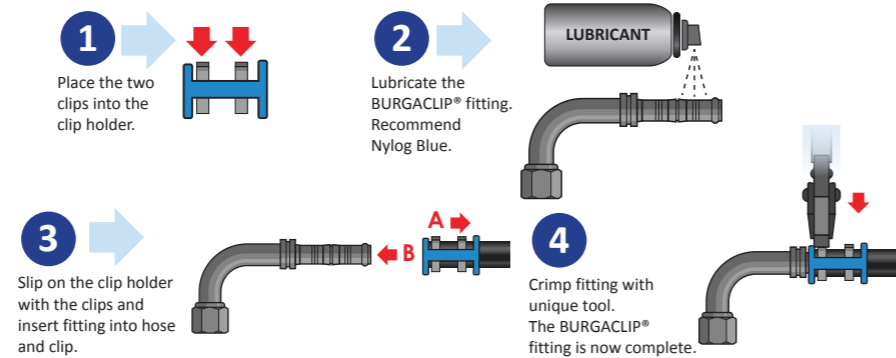

## BURGACLIP® - Fitting Connection Information

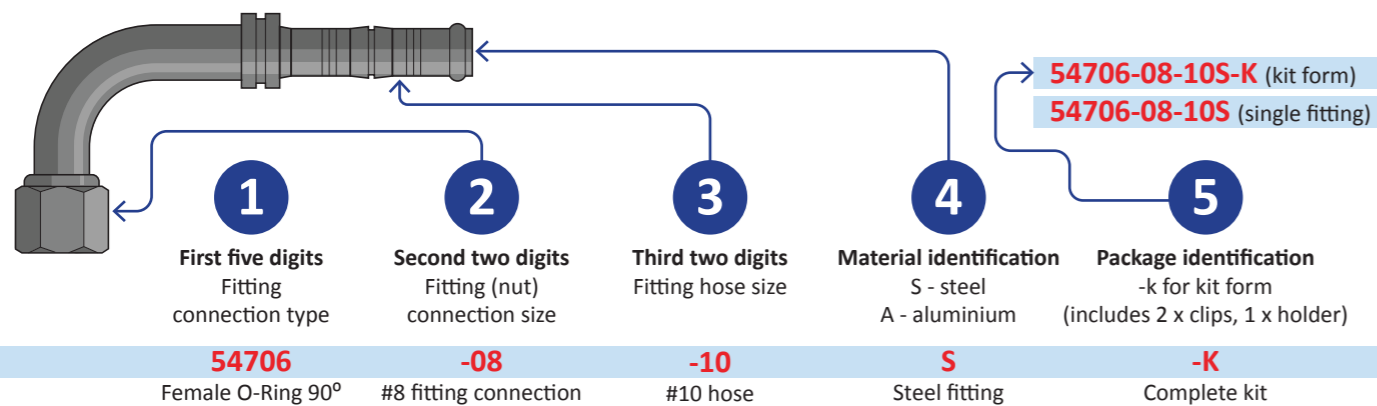

## Definition - Run and Drop

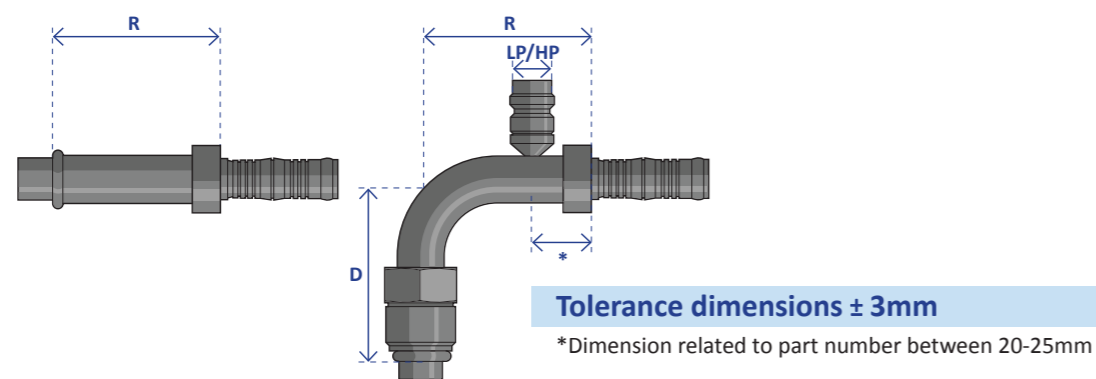

Can't find the right size, require a custom configuration or are an OEM in need of a tailored solution? Contact us.

Burgaflex Asia Pacific Pty Ltd  
14 Motorway Circuit Ormeau 4208 QLD, Australia  
Phone: +61 7 55 494 022  
Email: sales@burgaflex.com.au

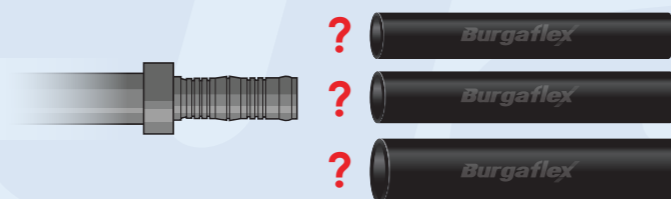

# Premium Hose Solution



**Temperature range:** -40°C to +135°C @ 514 psi (35 bar) continuous

**Specification:** Meets SAE J2064 Type C Class I hose performance

**Compatible with:** R134a, R404a, R410a, R457a, R513a, HFO1234yf/yz and many other low-temperature refrigerants. PAG, modified PAGs. POE and PVE refrigerant oils.

## 3390 Veneer Capillary Service Hose

### Hose construction

Extruded polyamide innertube, covered with a backing layer and textile reinforced with one braid. Hose has weather, oil and abrasion resistant rubber cover of EPDM, which is perforated.

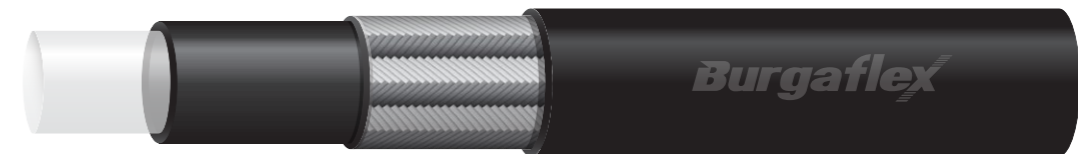

Part No.	Hose size	Hose ID	Hose OD (mm)	Working pressure (bar)	Burst pressure (bar)	Bend radius (mm)
3390-04*	#4 3/16"	4.8	9.5	35	>350	40

\*Hose quantity: per metre as displayed, \*(-5) = 5m, \*(-15) = 15m, \*(-R) = complete reel.  
Example: Use part number '3390-04' to order 1 metre of the product, '3390-04-5' to order 5 metres or '3390-04-R' for a complete reel.

## 3090 & 3080 MULTICOOL Reduced Barrier Hose

### Hose construction

Seamless synthetic rubber (CR) innertube, covered with a nylon layer and reinforced with one braid. Hose has weather, oil and abrasion resistant rubber cover of butyl, which is perforated.

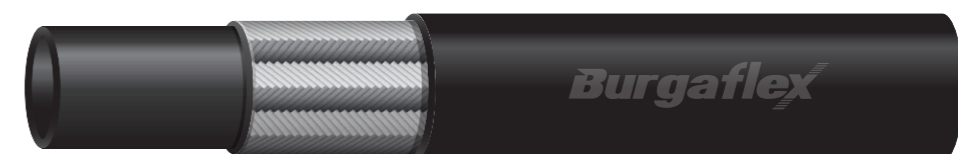

Part No.	Hose size (automotive)	Hose ID		Hose OD (mm)		Working pressure (bar)	Burst pressure (bar)	Bend radius (mm)
		min.	max.	min.	max.			
3090-06*	#6 5/16"	7.9	8.6	14.2	15.2	35	172	51
3090-08*	#8 13/32"	10.2	11.2	16.8	17.8	35	172	64
3090-10*	#10 1/2"	12.5	13.5	18.9	19.9	35	121	76
3090-12*	#12 5/8"	15.6	16.6	23.1	24.1	35	121	102
3080-14*	#14 3/4"	18.9	19.9	28.1	29.1	35	121	250

\*Hose quantity: per metre as displayed, \*(-15) = 15m, \*(-R) = complete reel.  
Example: Use part number '3090-06' to order 1 metre of the product, '3090-06-15' to order 15 metres, or '3090-06-R' for a complete reel.

## Hose Selection

To secure good suction line performance, it is imperative the correct hose or pipe size is implemented in the system. Suction line pressure drop is commonly caused by under sizing of the hose or pipe diameter as it relates to the refrigerant flow required for the system. The basic

principle of this is that larger diameter hose is required as the length of the suction line increases, or when refrigerant flow demand increases in the line from higher compressor capacity and rpm.

The rules used by Burgaflex & Unicla for suction line size calculations are

outlined in the ASHRAE Hand Book, Refrigeration Volume, 2006 Edition. This provides for suction line hose or pipe size recommendations, so any pressure drop from friction is no greater than approximately 1K change in saturation temperature in the line when operating at 0°C.

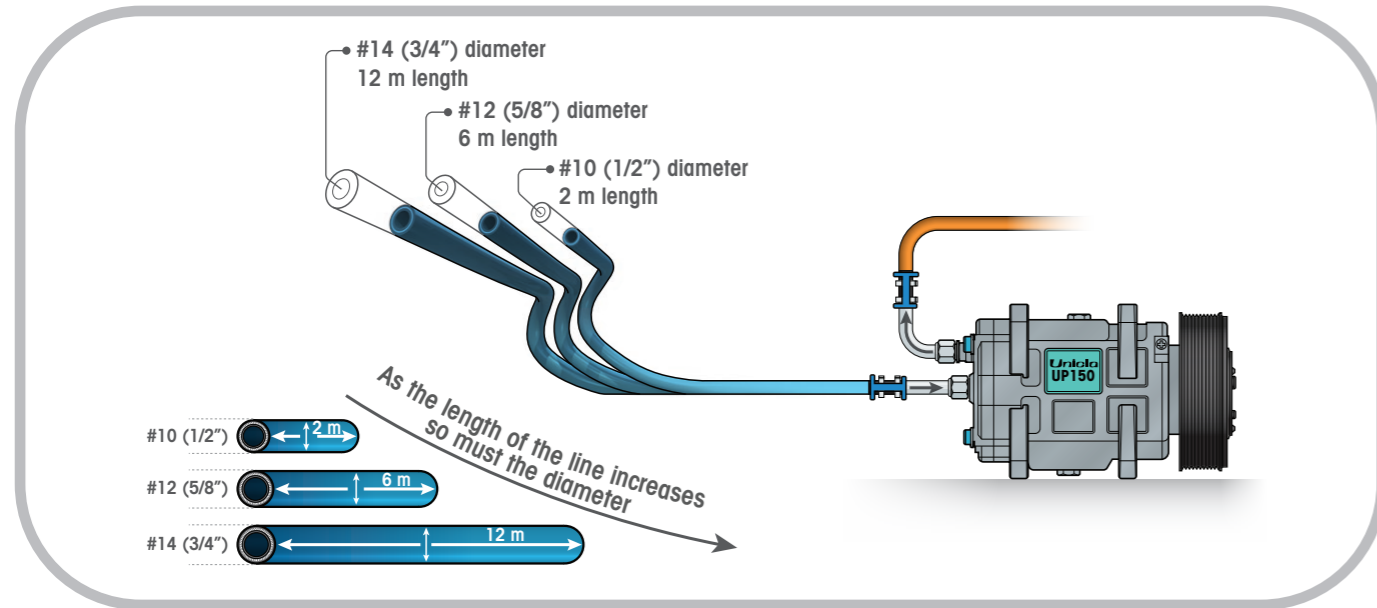

Diagram 1. A system with a 150cc compressor operating between 2000-3800 rpm continuous will require different size diameter suction lines as the length of the line increases.

## Suction line analysis

A suction line analysis is completed by taking both pressure and temperature measurements between the two points A and B as shown in this diagram. In this normal healthy suction line the pressure is the same at both points (1.82 bar or -1°C), and the temperature is 8°C at point A and 9°C at point B. This means only 1°C additional temperature (or superheat) has been picked up in the line during operation, which is very typical and normal for most systems.

The superheat at any particular point is calculated by taking the actual line temperature and deducting the saturation temperature of the refrigerant (Refer to R134a Pressure and Temperature Chart) at the same point.

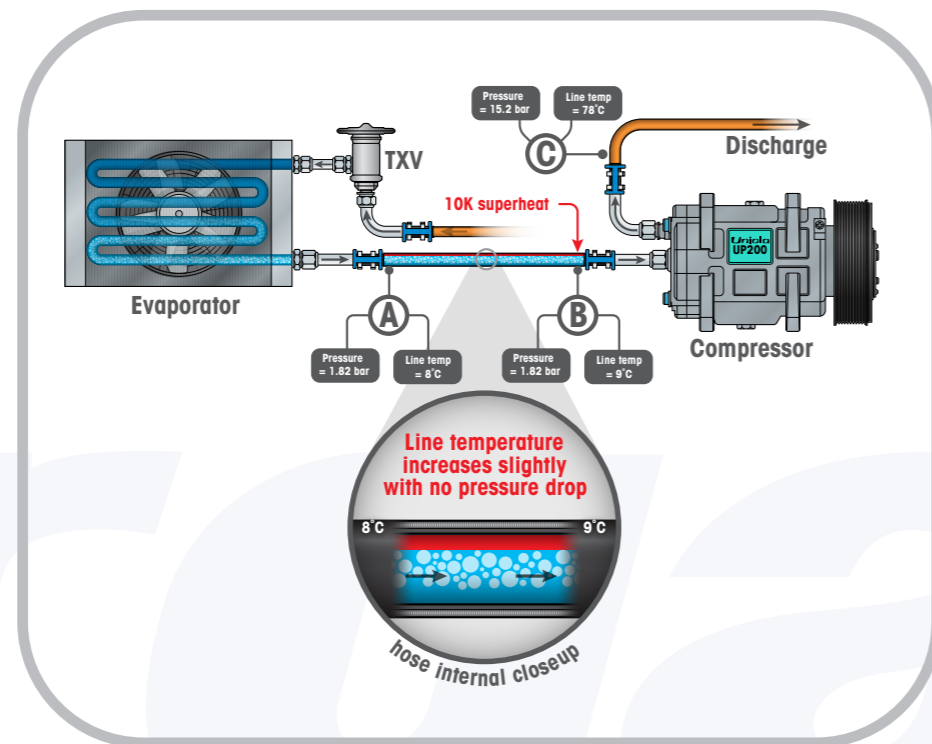

Diagram 2. System operating normally with Unicla UP200 operating at 2000 rpm, high side 15.2 bar. Low side 1.82 bar. Superheat 10K. Sub-cooling 5K. Compressor capacity is 8kW.

Therefore the complete analysis of the suction line and its relationship to the discharge line is shown in the table below.

Measuring point	Position	Pressure	Pressure drop	Refrigerant temp*	Line temp	Superheat and pressure drop	Diagnosis
A	Evaporator outlet	1.82 bar	Nil	-1°C	8°C	9K	Normal
B	Compressor suction	1.82 bar	Nil	-1°C	9°C	10K	Normal
C	Compressor discharge	15.2 bar	Nil	58°C	78°C	20K	Normal

\*From R134a pressure and temperature chart.

†Degrees Kelvin or K is the primary unit of temperature measurement in the physical sciences, and is often used in conjunction with degrees Celsius and whenever reference is made to superheat in a refrigeration system. Both K and °C have the same magnitude.

Table 1. Suction line and discharge line analysis of normal system shown in Diagram 2.

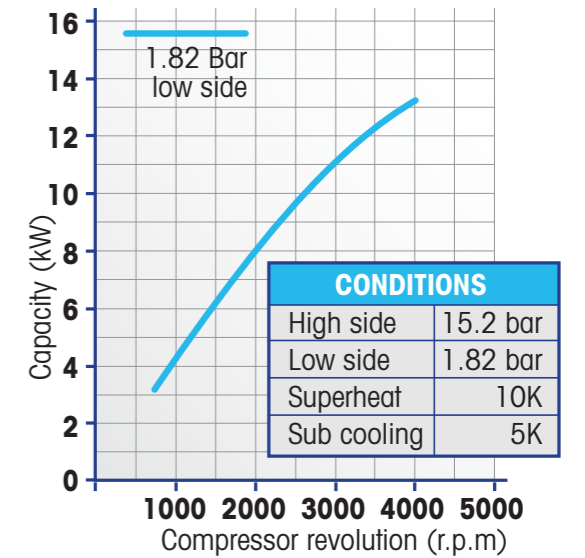

Graph 1.

## Suction line pressure drop

The most prominent feature of poor refrigerant flow in the suction line is the decrease in compressor capacity and cooling. This poor refrigerant flow can easily be diagnosed by analysing the line for pressure drop between point A and B as shown in Diagrams 2 and 3. No difference in pressure between these two points indicates a healthy functional line (Diagram 2), however if excessive pressure drop is present, an investigation should be undertaken to determine the cause.

The following Diagram 3 shows the reduction in cooling capacity of the same Unicla UP200 compressor operating in typical conditions on a system with a suction line pressure drop of 1.2 bar. Capacity reduction is a hefty 58%.

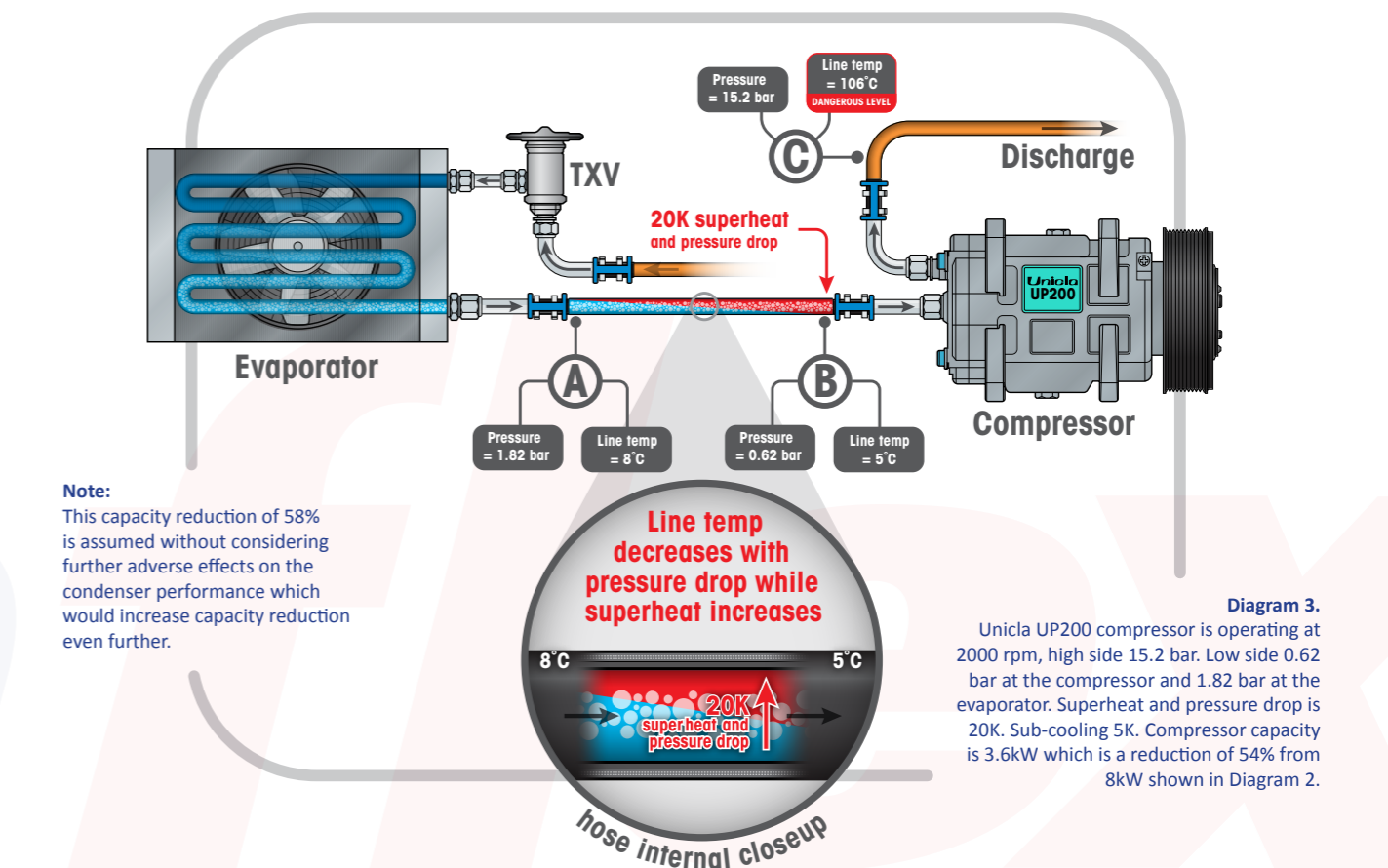

Note:

This capacity reduction of 58% is assumed without considering further adverse effects on the condenser performance which would increase capacity reduction even further.

Diagram 3.

Unicla UP200 compressor is operating at 2000 rpm, high side 15.2 bar. Low side 0.62 bar at the compressor and 1.82 bar at the evaporator. Superheat and pressure drop is 20K. Sub-cooling 5K. Compressor capacity is 3.6kW which is a reduction of 54% from 8kW shown in Diagram 2.

# The Importance of Suction Lines



The complete analysis of the suction line with pressure drop, and its relationship to the discharge line is shown in the Table 2 below. The effect on the compressor is quite dramatic, the combination of the pressure drop and even more superheat accumulation in line amounts to a total of 20K.

Calculated as follows:

7K (pressure drop) + 4K (extra superheat in the line) +9K (original superheat in evaporator) =20K

Measuring point	Position	Pressure	Pressure drop	Refrigerant temp*	Line temp	Superheat and pressure drop	Diagnosis
A	Evaporator outlet	1.82 bar	Nil	-1°C	8°C	9K	Normal
B	Compressor suction	0.62 bar	1.2 bar	-15°C	5°C	20K	Reduced capacity
C	Compressor discharge	15.2 bar	-	58°C	106°C	48K	Compressor overheating

\*From R134a pressure and temperature chart.  
 †Degrees Kelvin or K is the primary unit of temperature measurement in the physical sciences, and is often used in conjunction with degrees Celsius and whenever reference is made to superheat in a refrigeration system. Both K and °C have the same magnitude.

Table 2. Suction line and discharge line analysis of system with suction line pressure drop as shown in Diagram 2.

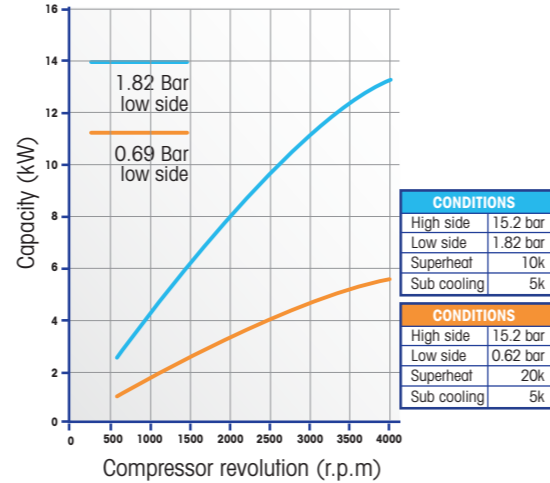

Graph 2.

This high temperature in the suction line reduces the capacity of the compressor and its cooling (as shown in Graph 2). The discharge line temperature rises to 106°C which places the compressor and its lubricant in the danger zone for a breakdown or complete failure.

In most cases, any discharge line with superheat levels in excess of 40°C is not only placing the compressor in danger, but is also an indication of possible pressure drop or restriction in the suction line causing capacity reduction. In these situations, both symptoms are undesirable and corrective action is required by repairing or replacing the suction to the correct size or condition.

A tip to remember is at 2000 rpm, systems with Unicla 45cc to 200cc compressors will produce discharge line superheat levels equal to approximately double the level of combined suction line temperature and pressure drop. In this example  $2 \times 20^\circ\text{C} = 40^\circ\text{C}$ , as compared to actual discharge line temperature of  $48^\circ\text{C}$ .

## Connection Guide - Flare Fittings

These are the standard flare connection sizes – in many cases a step up or double step may be required to achieve minimal pressure drop in the fitting due to the ID reduction at the fitting tail.

Fitting connection	Flare fitting size	Fitting outlet (ID)
#4	1/4"	2.40 mm
#6	3/8"	4.30 mm
#8	1/2"	6.50 mm
#10	5/8"	9.50 mm
#12	3/4"	12.30 mm
#14	~	14.90 mm

# Fitting Selection



## Fitting Selection

The most common mistake made by system designers and technicians in the field is determining the suction hose size based on the dimensions or size of the connection points on the evaporator or the compressor. As an example, if a system has #10 fittings at both the compressor and evaporator, and the correct hose requirement is to utilise a #12 line, the correct course of action is to use single step up fittings (#10 - #12) at each end so the #12 hose can be used.

fact only #10 connection points are at each end. The most ideal situation would be to have #12 sizes over the complete suction line, however the effect of simply having #10 connection points at the ends is minimal, whereas the effects of total pressure drop in the line from using #10 over the complete line could be quite serious.

It is a complete misconception to assume the advantages of using step-up fittings and #12 hose in this example, are negated by the

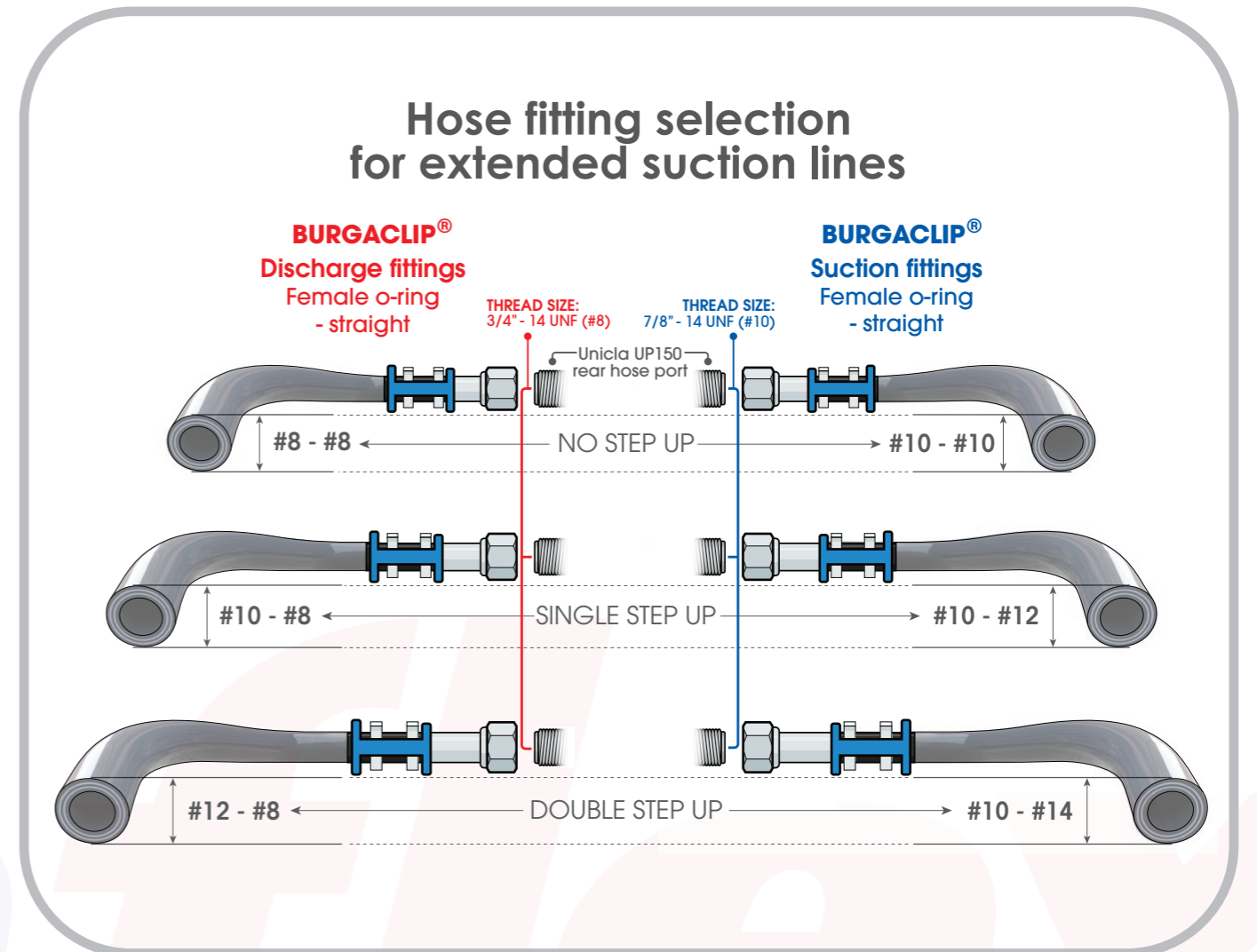

To take this point even further, the requirement to step up the hose size from the available connection point can sometimes necessitate going to the next size again. So to achieve this, 'double step up' Burgaclip fittings are now available from Burgaflex as shown below.



**Burgaclip step up fittings available in all connection types from #4 (1/4") to #14 (3/4")**



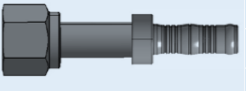

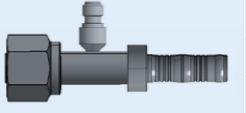
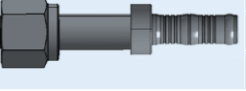
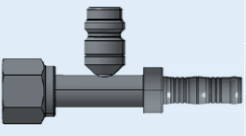
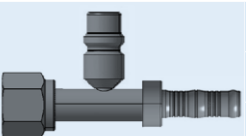
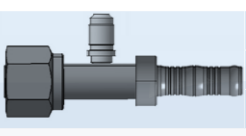
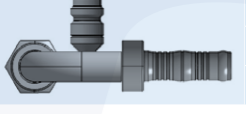
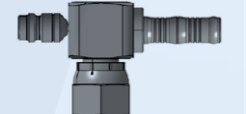
# Table of Contents

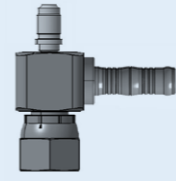
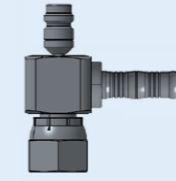

Type		Part No.	Description	Page
Burgaflex hose		3390	Rubber hose #4	03
		3090	Rubber hose #6 - #12	03
		3080	Rubber hose #14	03
Female Flare (SAE 45° flare)		54701	FF straight	12
		54702	FF 45°	12
		54703	FF 90°	12
		55701	FF straight 1/4 fitting	12
		55703	FF 90° 1/4 fitting	13
Male Insert O-Ring		54206	MIOR straight	14
		54207	MIOR 45°	14
		54208	MIOR 90°	14
Male O-Ring		54213	MOR straight	15
		54214	MOR 90°	15
		54215	MOR 45°	15
		54217	MOR 90° with R134a valve	15
Female O-Ring swivel - switch adaptor M10x1.25		54617	FOR straight	16
		54618	FOR 45°	16
		54619	FOR 90°	16
Female O-Ring		54704	FOR straight	17
		54705	FOR 45°	17
		54706	FOR 90°	17
Female O-Ring with R1234a valve		54717	FOR straight with R134a valve	18
		54718	FOR 45° with R134a valve	18
		54719	FOR 90° with R134a valve	18
Female O-Ring with R1234yf valve		54737	FOR straight with R1234YF valve	19
		54738	FOR 45° with R1234YF valve	19
		54739	FOR 90° with R1234YF valve	19
Female O-Ring with 7/16" valve		54710	FOR straight with 7/16" valve	20
		54711	FOR 45° with 7/16" valve	20
		54712	FOR 90° with 7/16" valve	20
Female O-Ring swivel - with side port		54785	FOR 90° with R134a valve - left	21
		54786	FOR 90° with R134a valve - right	21
		541000	FOR 90° with male insert valve - right	21
Female O-Ring swivel 90° - block type		54412	FOR block type with R134a valve - forward	22

# Table of Contents

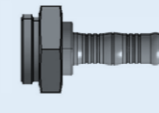
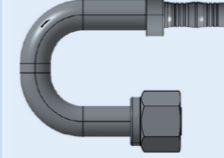
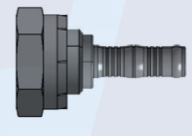
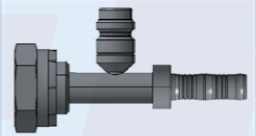
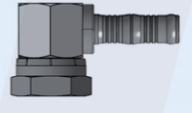

Type		Part No.	Description	Page
Female O-Ring swivel 90° - block type		54740	FOR block type 90°	22
		54741	FOR block type 90° with 7/16" valve - top	22
		54742	FOR block type 90° with R134a valve - top	22
Female O-Ring swivel 90° - block type - short type		54420	FOR block type with R134a valve top - short drop	23
		54421	FOR block type - short drop	23
		54422	FOR block type with R134a valve forward - short drop	23
Female O-Ring without nut		54724	FOR straight without nut	24
		54725	FOR 45° without nut	24
		54726	FOR 90° without nut	24
		54729	FOR 90° without nut with R134a valve	24
Female O-Ring TXV connection incl. TXV plate		54304	FOR TXV connection straight	25
		54305	FOR TXV connection 45°	25
		54306	FOR TXV connection 90°	25
Female O-Ring long pilot TXV connection		54751	FOR TXV connection straight	26
		54752	FOR TXV connection 45°	26
		54753	FOR TXV connection 90°	26
Quick disconnect		54747	Quick disconnect straight	27
		54748	Quick disconnect 90°	27
Female O-Ring - 180°		54771	FOR Straight 180°	27
Tube-O compressor fitting		54707	Tube-O straight	28
		54708	Tube-O 45°	28
		54709	Tube-O block type 90°	28
Tube-O with R134a		54733	Tube-O with R134a valve - Straight	29
		54734	Tube-O with R134a valve - 45°	29
		54735	Tube-O with R134a valve - 90°	29
Tube-O Hex block 90°		54450	Tube-O HEX block 90°	30
		54451	Tube-O HEX block 90° with R134a valve - top	30
		54453	Tube-O HEX block 90° with R134a valve - 120°	30
		54454	Tube-O HEX block 90° with R134a valve - forward	30
		54455	Tube-O HEX block 90° with R134a valve - 240°	30

# Table of Contents



Type		Part No.	Description	Page
Female O-Ring HEX block 90°		54425	FOR HEX block 90°	31
		54426	FOR HEX block 90° with R134a valve - top	31
		54427	FOR HEX block 90° with R134a valve - forward	31
		54428	FOR HEX block 90° with 7/16-20 valve - top	31
ORFS Female swivel		54501	ORFS straight	32
		54502	ORFS 45°	32
		54503	ORFS 90°	32
Male Insert O-Ring - Bulkhead		54758	MIOR bulkhead straight	33
		54759	MIOR bulkhead 90°	33
		54760	MIOR bulkhead 45°	33
In-line splicer		548753	In-line splicer	34
		548760	In-line splicer with O-ring insert	34
		548761	In-line splicer 90° elbow	34
In-line splicer with valve		548751	In-line splicer with R134a valve	35
		548754	In-line splicer with MF 7/16" valve	35
		547999	In-line splicer with R1234YF valve	35
In-line splicer 90°		548749	In-line splicer 90°	36
In-line splicer T		548750	In-line splicer T-piece	36
In-line splicer Y		548752	In-line splicer Y-piece	36
Braze nipple		54743-A	Braze nipple alluminium	37
		54743-S	Braze nipple steel	37
Valve caps and cores		7042	Protection cap 7/16-20 pressure sensor connection	38
		7037	Protection cap 7034/7036	38
		7038	Protection cap 7035	38
		7039	Valve core 7035	38
Caps and O-Rings		7028	O-rings	38
		10134	Female fitting cap	38
		10133	Male fitting cap	38



# Table of Contents



Type		Part No.	Description	Page
Tools		8766	Crimping pliers	39
		8767	Hose cutters	39
Clips and Holders		8768	Metal clip	40
		8769	Plastic clip holder	40

# Hose Fittings

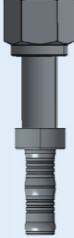
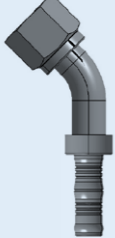

Description		Part No.	Fitting connection	Hose size	Thread	Valve	D	R
Straight		54701-04-06S	-4	-6	7/16-20	-	-	36
		54701-06-06S	-6	-6	5/8-18	-	-	27
		54701-06-08S	-6	-8	5/8-18	-	-	27
		54701-08-06S	-8	-6	3/4-16	-	-	30
		54701-08-08S	-8	-8	3/4-16	-	-	30
		54701-08-10S	-8	-10	3/4-16	-	-	30
		54701-10-08S	-10	-8	7/8-14	-	-	33
		54701-10-10S	-10	-10	7/8-14	-	-	33
		54701-10-12S	-10	-12	7/8-14	-	-	33
		54701-10-14S	-10	-14	7/8-14	-	-	33
		54701-12-12S	-12	-12	1 1/16-14	-	-	38
		54701-12-14S	-12	-14	1 1/16-14	-	-	38
45° elbow		54702-04-06S	-4	-6	7/16-20	-	18	46
		54702-06-06S	-6	-6	5/8-18	-	15	40
		54702-08-06S	-8	-6	3/4-16	-	15	47
		54702-08-08S	-8	-8	3/4-16	-	15	47
		54702-08-10S	-8	-10	3/4-16	-	15	47
		54702-10-08S	-10	-8	7/8-14	-	25	52
		54702-10-10S	-10	-10	7/8-14	-	25	52
		54702-10-12S	-10	-12	7/8-14	-	25	52
		54702-10-14S	-10	-14	7/8-14	-	25	52
		54702-12-12S	-12	-12	1 1/16-14	-	27	62
		54702-12-14S	-12	-14	1 1/16-14	-	27	62
		90° elbow		54703-04-06S	-4	-6	7/16-20	-
54703-06-06S	-6			-6	5/8-18	-	27	52
54703-06-08S	-6			-8	5/8-18	-	27	52
54703-08-06S	-8			-6	3/4-16	-	35	60
54703-08-08S	-8			-8	3/4-16	-	35	60
54703-08-10S	-8			-10	3/4-16	-	35	60
54703-10-08S	-10			-8	7/8-14	-	38	60
54703-10-10S	-10			-10	7/8-14	-	38	60
54703-10-12S	-10			-12	7/8-14	-	38	60
54703-10-14S	-10			-14	7/8-14	-	38	60
54703-12-12S	-12			-12	1 1/16-14	-	50	75
54703-12-14S	-12			-14	1 1/16-14	-	50	75

Female Flare (SAE 45° flare)

# Hose Fittings

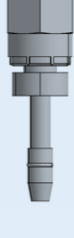
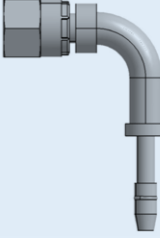

Part No.	Fitting connection	Hose size	Thread	Valve	D	R		Description
55701-04-04S	-4	-4	7/16-20	-	-	-		Straight
55703-04-04S	-4	-4	7/16-20	-	-	-		90° elbow

Female Flare (SAE 45° flare)

# Hose Fittings



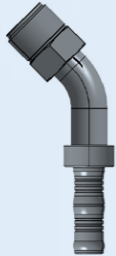
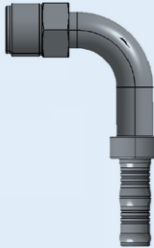

Description		Part No.	Fitting connection	Hose size	Thread	Valve	D	R
Straight		54206-06-06S	-6	-6	5/8-18	-	-	22
		54206-08-08S	-8	-8	3/4-16	-	-	25
		54206-10-10S	-10	-10	7/8-14	-	-	30
		54206-10-12S	-10	-12	7/8-14	-	-	30
		54206-10-14S	-10	-14	7/8-14	-	-	30
		54206-12-12S	-12	-12	1 1/16-14	-	-	34
		54206-12-14S	-12	-14	1 1/16-14	-	-	50
45° elbow		54207-06-06S	-6	-6	5/8-18	-	30	75
		54207-08-08S	-8	-8	3/4-16	-	35	90
		54207-10-10S	-10	-10	7/8-14	-	35	95
		54207-10-14S	-10	-14	7/8-14	-	35	95
		54207-12-12S	-12	-12	1 1/16-14	-	45	105
		54207-12-14S	-12	-14	1 1/16-14	-	45	105
90° elbow		54208-06-06S	-6	-6	5/8-18	-	40	55
		54208-08-08S	-8	-8	3/4-16	-	55	65
		54208-10-10S	-10	-10	7/8-14	-	65	70
		54208-10-14S	-10	-14	7/8-14	-	65	70
		54208-12-12S	-12	-12	1 1/16-14	-	75	75
		54208-12-14S	-12	-14	1 1/16-14	-	75	75

Male Insert O-Ring

# Hose Fittings

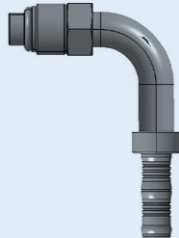
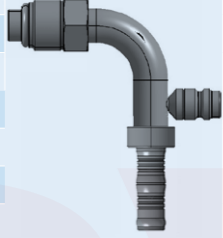

Part No.	Fitting connection	Hose size	Thread	Valve	D	R		Description
54213-06-06S	-6	-6	5/8-18	-	-	38		Straight
54213-06-08S	-6	-8	5/8-18	-	-	38		
54213-08-08S	-8	-8	3/4-18	-	-	45		
54213-10-10S	-10	-10	7/8-18	-	-	55		
54213-10-12S	-10	-12	7/8-18	-	-	55		
54213-10-14S	-10	-14	7/8-18	-	-	55		
54213-12-10S	-12	-10	1 1/16-16	-	-	55		
54213-12-12S	-12	-12	1 1/16-16	-	-	60		
54213-12-14S	-12	-14	1 1/16-16	-	-	60		
54215-06-06S	-6	-6	5/8-18	-	22	40		45° elbow
54215-08-08S	-8	-8	3/4-18	-	25	55		
54215-10-10S	-10	-10	7/8-18	-	27	67		
54215-10-12S	-10	-12	7/8-18	-	27	67		
54215-10-14S	-10	-14	7/8-18	-	27	67		
54215-12-12S	-12	-12	1 1/16-16	-	35	80		
54215-12-14S	-12	-14	1 1/16-16	-	35	80		
54214-06-06S	-6	-6	5/8-18	-	40	32		90° elbow
54214-06-08S	-6	-8	5/8-18	-	40	32		
54214-08-08S	-8	-8	3/4-18	-	45	40		
54214-10-10S	-10	-10	7/8-18	-	52	50		
54214-10-12S	-10	-12	7/8-18	-	52	50		
54214-10-14S	-10	-14	7/8-18	-	52	50		
54214-12-10S	-12	-10	1 1/16-16	-	52	50		
54214-12-12S	-12	-12	1 1/16-16	-	60	60		
54214-12-14S	-12	-14	1 1/16-16	-	60	60		
54217-06-06HPS	-6	-6	5/8-18	16 (HP)	40	32		90° elbow with R134a valve
54217-08-08HPS	-8	-8	3/4-18	16 (HP)	45	40		
54217-10-10LPS	-10	-10	7/8-18	13 (LP)	52	50		
54217-12-12LPS	-12	-12	1 1/16-16	13 (LP)	60	60		

Male O-Ring



# Hose Fittings

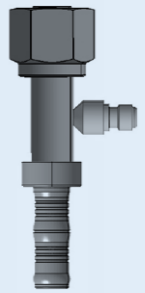
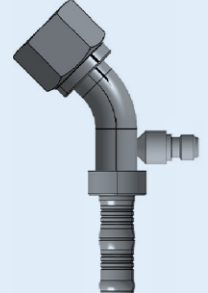
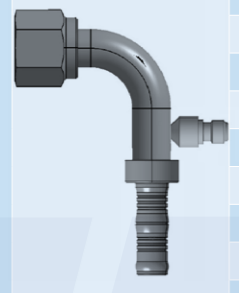

Female O-Ring swivel - switch adaptor M10x1.25

Description		Part No.	Fitting connection	Hose size	Thread	Valve	D	R
Straight		54617-06-06S	-6	-6	5/8-18	M10x1.25	-	46
		54617-08-08S	-8	-8	3/4-16	M10x1.25	-	40
		54617-10-10S	-10	-10	7/8-14	M10x1.25	-	50
		54617-12-12S	-12	-12	1 1/16-14	M10x1.25	-	55
45° elbow		54618-06-06S	-6	-6	5/8-18	M10x1.25	15	45
		54618-08-08S	-8	-8	3/4-16	M10x1.25	15	52
		54618-10-10S	-10	-10	7/8-14	M10x1.25	17	55
		54618-12-12S	-12	-12	1 1/16-14	M10x1.25	25	65
90° elbow		54619-06-06S	-6	-6	5/8-18	M10x1.25	30	40
		54619-08-08S	-8	-8	3/4-16	M10x1.25	35	50
		54619-10-10S	-10	-10	7/8-14	M10x1.25	40	57
		54619-12-12S	-12	-12	1 1/16-14	M10x1.25	45	65

# Hose Fittings



Female O-Ring

Part No.	Fitting connection	Hose size	Thread	Valve	D	R		Description
54704-06-06S	-6	-6	5/8-18	-	-	37		Straight
54704-06-08S	-6	-8	5/4-16	-	-	37		
54704-08-06S	-8	-6	3/4-16	-	-	40		
54704-08-08S	-8	-8	3/4-16	-	-	40		
54704-08-10S	-8	-10	3/4-16	-	-	40		
54704-08-12S	-8	-12	3/4-16	-	-	40		
54704-10-08S	-10	-8	7/8-14	-	-	50		
54704-10-10S	-10	-10	7/8-14	-	-	50		
54704-10-12S	-10	-12	7/8-14	-	-	50		
54704-10-14S	-10	-14	7/8-14	-	-	50		
54704-12-10S	-12	-10	1 1/16-14	-	-	50		
54704-12-12S	-12	-12	1 1/16-14	-	-	55		
54704-12-14S	-12	-14	1 1/16-14	-	-	55		
54705-06-06S	-6	-6	5/8-18	-	15	37		
54705-06-08S	-6	-8	5/8-14	-	15	37		
54705-08-06S	-8	-6	3/4-16	-	15	52		
54705-08-08S	-8	-8	3/4-16	-	15	52		
54705-08-10S	-8	-10	3/4-16	-	15	52		
54705-10-10S	-10	-10	7/8-14	-	17	55		
54705-10-12S	-10	-12	7/8-14	-	17	55		
54705-10-14S	-10	-14	7/8-16	-	17	55		
54705-12-10S	-12	-10	1 1/16-14	-	17	55		
54705-12-12S	-12	-12	1 1/16-14	-	25	65		
54705-12-14S	-12	-14	1 1/16-14	-	25	65		
54706-06-06S	-6	-6	5/8-18	-	30	40		90° elbow
54706-06-08S	-6	-8	5/8-18	-	30	40		
54706-08-06S	-8	-6	3/4-16	-	35	50		
54706-08-08S	-8	-8	3/4-16	-	35	50		
54706-08-10S	-8	-10	3/4-16	-	35	50		
54706-08-12S	-8	-12	3/4-16	-	35	50		
54706-10-06S	-10	-6	7/8-14	-	40	60		
54706-10-08S	-10	-8	7/8-14	-	40	60		
54706-10-10S	-10	-10	7/8-14	-	40	57		
54706-10-12S	-10	-12	7/8-14	-	40	57		
54706-10-14S	-10	-14	7/8-14	-	40	57		
54706-12-10S	-12	-10	1 1/16-14	-	45	65		
54706-12-12S	-12	-12	1 1/16-14	-	45	65		
54706-12-14S	-12	-14	1 1/16-14	-	45	65		

# Hose Fittings



Description	Part No.	Fitting connection	Hose size	Thread	Valve	D	R
Straight	54717-06-06HPS	-6	-6	5/8-16	16 (HP)	-	46
	54717-08-08HPS	-8	-8	3/4-16	16 (HP)	-	40
	54717-08-10LPS	-8	-10	3/4-16	13 (LP)	-	40
	54717-10-10LPS	-10	-10	7/8-14	13 (LP)	-	50
	54717-10-12LPS	-10	-12	7/8-14	13 (LP)	-	50
	54717-12-12LPS	-12	-12	1 1/16-14	13 (LP)	-	55
	54717-12-14LPS	-12	-14	1 1/16-14	13 (LP)	-	55

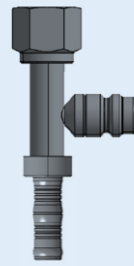

45° elbow	54718-06-06HPS	-6	-6	5/8-18	16 (HP)	15	37
	54718-08-08HPS	-8	-8	3/4-16	16 (HP)	15	52
	54718-10-10HPS	-10	-10	7/8-14	16 (HP)	17	55
	54718-10-10LPS	-10	-10	7/8-14	13 (LP)	17	55
	54718-10-12LPS	-10	-12	7/8-14	13 (LP)	17	55
	54718-12-12LPS	-12	-12	1 1/16-14	13 (LP)	25	65
	54718-12-14LPS	-12	-14	1 1/16-14	13 (LP)	25	65

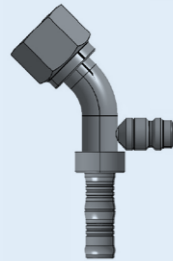

90° elbow	54719-06-06HPS	-6	-6	5/8-18	16 (HP)	30	40
	54719-06-08HPS	-6	-8	5/8-18	16 (HP)	30	40
	54719-08-08HPS	-8	-8	3/4-16	16 (HP)	35	50
	54719-08-10HPS	-8	-10	3/4-16	16 (HP)	35	50
	54719-08-12HPS	-8	-12	3/4-16	16 (HP)	35	50
	54719-10-08HPS	-10	-8	7/8-14	16 (HP)	40	57
	54719-10-10HPS	-10	-10	7/8-14	16 (HP)	40	57
	54719-10-10LPS	-10	-10	7/8-14	13 (LP)	40	57
	54719-10-12LPS	-10	-12	7/8-14	13 (LP)	40	57
	54719-12-12LPS	-12	-12	1 1/16-14	13 (LP)	45	65
	54719-12-14LPS	-12	-14	1 1/16-14	13 (LP)	45	65

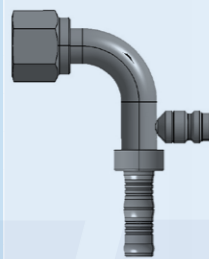

# Hose Fittings



Part No.	Fitting connection	Hose size	Thread	Valve	D	R	Description
54737-06-06HPS	-6	-6	5/8-18	17 (HP)	-	46	Straight
54737-08-08HPS	-8	-8	3/4-16	17 (HP)	-	40	
54737-08-10LPS	-8	-10	3/4-16	14 (LP)	-	40	
54737-10-10LPS	-10	-10	7/8-14	14 (LP)	-	50	
54737-10-12LPS	-10	-12	7/8-14	14 (LP)	-	50	
54737-12-12LPS	-12	-12	1 1/16-14	14 (LP)	-	55	
54737-12-14LPS	-12	-14	1 1/16-14	14 (LP)	-	55	

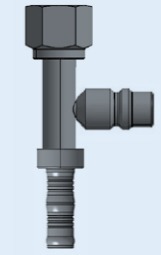

54738-06-06HPS	-6	-6	5/8-18	17 (HP)	15	45	45° elbow
54738-08-08HPS	-8	-8	3/4-16	17 (HP)	15	52	
54738-10-10LPS	-10	-10	7/8-14	14 (LP)	17	55	
54738-10-12LPS	-10	-12	7/8-14	14 (LP)	17	55	
54738-12-12LPS	-12	-12	1 1/16-14	14 (LP)	25	65	

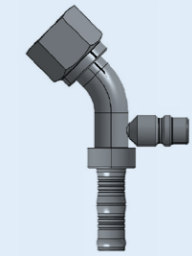

54739-06-06HPS	-6	-6	5/8-18	17 (HP)	30	40	90° elbow
54739-08-08HPS	-8	-8	3/4-16	17 (HP)	35	50	
54739-10-10LPS	-10	-10	7/8-14	14 (LP)	40	57	
54739-10-12LPS	-10	-12	7/8-14	14 (LP)	40	57	
54739-12-12LPS	-12	-12	1 1/16-14	14 (LP)	45	65	

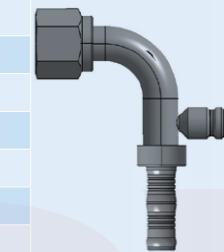

Female O-Ring with R134a valve

Female O-Ring with R1234yf valve

# Hose Fittings

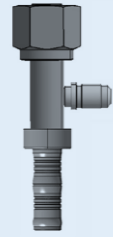
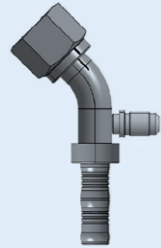
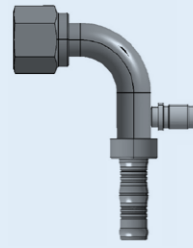

Description		Part No.	Fitting connection	Hose size	Thread	Valve	D	R
Straight		54710-06-06S	-6	-6	5/8-18	7/16-20	-	46
		54710-08-08S	-8	-8	3/4-16	7/16-20	-	40
		54710-10-10S	-10	-10	7/8-14	7/16-20	-	50
		54710-10-12S	-10	-12	7/8-14	7/16-20	-	50
		54710-12-12S	-12	-12	1 1/16-14	7/16-20	-	55
45° elbow		54711-06-06S	-6	-6	5/8-18	7/16-20	15	45
		54711-08-08S	-8	-8	3/4-16	7/16-20	15	52
		54711-10-10S	-10	-10	7/8-14	7/16-20	17	55
		54711-12-12S	-12	-12	1 1/16-14	7/16-20	25	65
90° elbow		54712-06-06S	-6	-6	5/8-18	7/16-20	30	40
		54712-08-08S	-8	-8	3/4-16	7/16-20	35	50
		54712-10-10S	-10	-10	7/8-14	7/16-20	40	57
		54712-10-12S	-10	-12	7/8-14	7/16-20	40	57
		54712-12-12S	-12	-12	1 1/16-14	7/16-20	45	65

Female O-Ring with 7/16" valve

# Hose Fittings

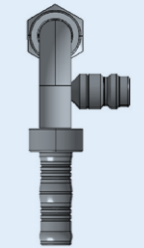
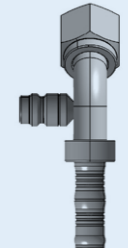
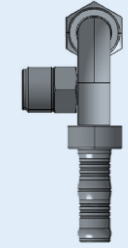

Part No.	Fitting connection	Hose size	Thread	Valve	D	R		Description
54785-06-06HPS	-6	-6	5/8-16	16 (HP)	30	40		90° elbow - left side valve
54785-08-08HPS	-8	-8	3/4-16	16 (HP)	35	50		
54785-10-10HPS	-10	-10	7/8-14	16 (HP)	40	57		
54785-10-10LPS	-10	-10	7/8-14	13 (LP)	40	57		
54785-12-12LPS	-12	-12	1 1/16-14	13 (LP)	45	65		
54786-06-06HPS	-6	-6	5/8-16	16 (HP)	15	45		45° elbow - right side valve
54786-08-08HPS	-8	-8	3/4-16	16 (HP)	15	52		
54786-08-08LPS	-8	-8	3/4-16	13 (LP)	15	52		
54786-10-10HPS	-10	-10	7/8-14	16 (HP)	17	55		
54786-10-10LPS	-10	-10	7/8-14	13 (LP)	17	55		
54786-12-12LPS	-12	-12	1 1/16-14	13 (LP)	25	65		
541000-08-08-06S	-8	-8	3/4-16	-6	30	40		90° elbow - right side male insert
541000-10-10-06S	-10	-10	7/8-14	-6	40	57		

Female O-Ring with side valve



# Hose Fittings

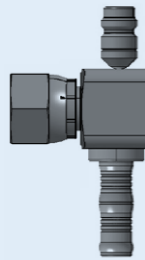
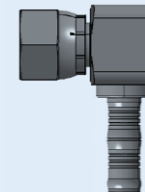
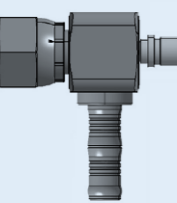
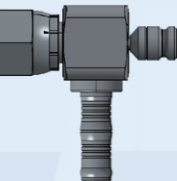

Description		Part No.	Fitting connection	Hose size	Thread	Valve	D	R
90° elbow with R134a valve - forward		54412-06-06HPS	-6	-6	5/8-18	16 (HP)	24	15
		54412-08-08HPS	-8	-8	3/4-16	16 (HP)	24	15
		54412-10-10LPS	-10	-10	7/8-14	13 (LP)	26	15
		54412-12-12LPS	-12	-12	1 1/16-14	13 (LP)	28	15
90° elbow		54740-06-06S	-6	-6	5/8-18	-	24	15
		54740-08-08S	-8	-8	3/4-16	-	24	15
		54740-10-10S	-10	-10	7/8-14	-	26	15
		54740-10-12S	-10	-12	7/8-14	-	26	15
		54740-12-12S	-12	-12	1 1/16-14	-	28	15
		54740-12-14S	-12	-14	1 1/16-14	-	28	15
90° elbow with 7/16-20 valve - top		54741-06-06S	-6	-6	5/8-18	7/16-20	24	15
		54741-08-08S	-8	-8	3/4-16	7/16-20	24	15
		54741-10-10S	-10	-10	7/8-14	7/16-20	26	15
		54741-10-12S	-10	-12	7/8-14	7/16-20	26	15
		54741-12-12S	-12	-12	1 1/16-14	7/16-20	28	15
90° elbow with R134a valve - top		54742-06-06HPS	-6	-6	5/8-18	16 (HP)	24	15
		54742-08-08HPS	-8	-8	3/4-16	16 (HP)	24	15
		54742-10-10LPS	-10	-10	7/8-14	13 (LP)	26	15
		54742-10-12LPS	-10	-12	7/8-14	13 (LP)	26	15
		54742-12-12LPS	-12	-12	1 1/16-14	13 (LP)	28	15
		54742-12-14LPS	-12	-14	1 1/16-14	13 (LP)	28	15

# Hose Fittings

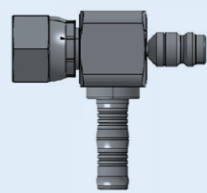
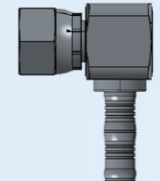
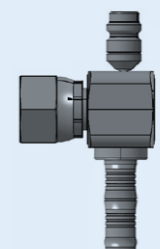

Part No.	Fitting connection	Hose size	Thread	Valve	D	R		Description
54420-06-06HPS	-6	-6	5/8-18	16 (HP)	13	15		90° elbow with R134a valve - top
54420-08-08HPS	-8	-8	3/4-16	16 (HP)	16	15		
54420-10-10LPS	-10	-10	7/8-14	13 (LP)	16	15		
54421-06-06S	-6	-6	5/8-18	-	13	15		90° elbow
54421-08-08S	-8	-8	3/4-16	-	16	15		
54421-10-08S	-10	-8	3/4-16	-	16	15		
54421-10-10S	-10	-10	7/8-14	-	16	15		
54422-06-06HPS	-6	-6	5/8-18	16 (HP)	13	15		90° elbow with R134a valve - forward
54422-08-08HPS	-8	-8	3/4-16	16 (HP)	16	15		
54422-10-08LPS	-10	-8	3/4-16	13 (LP)	16	15		
54422-10-10LPS	-10	-10	7/8-14	13 (LP)	16	15		

Female O-Ring swivel 90° - block type

Female O-Ring swivel 90° - block type - short drop

# Hose Fittings



Description		Part No.	Fitting connection	Hose size	Thread	Valve	D	R
Straight		54724-06-06S	-6	-6	-	-	-	37
		54724-06-08S	-6	-8	-	-	-	37
		54724-08-06S	-8	-6	-	-	-	40
		54724-08-08S	-8	-8	-	-	-	40
		54724-10-10S	-10	-10	-	-	-	50
		54724-10-12S	-10	-12	-	-	-	50
		54724-12-10S	-12	-10	-	-	-	55
		54724-12-12S	-12	-12	-	-	-	55
45° elbow		54725-06-06S	-6	-6	-	-	15	37
		54725-06-08S	-6	-8	-	-	15	37
		54725-08-06S	-8	-6	-	-	15	52
		54725-08-08S	-8	-8	-	-	15	52
		54725-10-10S	-10	-10	-	-	17	55
		54725-10-12S	-10	-12	-	-	17	55
		54725-12-10S	-12	-10	-	-	25	65
		54725-12-12S	-12	-12	-	-	25	65
90° elbow		54726-06-06S	-6	-6	-	-	30	40
		54726-08-08S	-8	-8	-	-	35	50
		54726-10-10S	-10	-10	-	-	40	57
		54726-10-12S	-10	-12	-	-	40	57
		54726-12-10S	-12	-10	-	-	45	65
		54726-12-12S	-12	-12	-	-	45	65
90° elbow with R134a valve - long pilot		54729-06-06HPS	-6	-6	-	16 (HP)	30	40
		54729-08-08HPS	-8	-8	-	16 (HP)	35	50
		54729-10-10LPS	-10	-10	-	13 (LP)	40	57
		54729-10-12LPS	-10	-12	-	13 (LP)	40	57
		54729-12-12LPS	-12	-12	-	13 (LP)	45	65

# Hose Fittings





Part No.	Fitting connection	Hose size	Thread	Valve	D	R		Description
54304-12-10S	-12	-10	-	-	-	55		Straight
54304-12-12S	-12	-12	-	-	55			
54305-12-10S	-12	-10	-	-	25	65		45° elbow
54305-12-12S	-12	-12	-	-	25	65		
54306-12-10S	-12	-10	-	-	45	65		90° elbow
54306-12-12S	-12	-12	-	-	45	65		

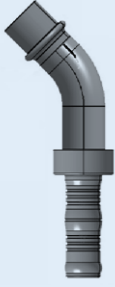

Female O-Ring without nut

Female O-Ring TXV connection incl. TXV plate

Description		Part No.	Fitting connection	Hose size	Thread	Valve	D	R	
Straight		54751-12-10S	-12	-10	-	-	-	53	
45° elbow		54752-12-10S	-12	-10	-	-	15	55	
90° elbow		54753-12-10S	-12	-10	-	-	45	55	

Part No.	Fitting connection	Hose size	Thread	Valve	D	R		Description
54747-08-06S	-8	-6	M18X1,5	-	-	25		Straight
54747-08-08S	-8	-8	M18X1,5	-	-	25		
54747-10-06S	-10	-6	7/8-20	-	-	25		
54747-10-08S	-10	-8	7/8-20	-	-	25		
54747-10-10S	-10	-10	7/8-20	-	-	25		
54747-12-10S	-12	-10	1 1/4-18	-	-	25		
54747-12-12S	-12	-12	1 1/4-18	-	-	25		
54748-08-06S	-8	-6	M18X1,5	-	30	25		90° elbow
54748-08-08S	-8	-8	M18X1,5	-	35	25		
54748-10-06S	-10	-6	7/8-20	-	40	25		
54748-10-08S	-10	-8	7/8-20	-	40	25		
54748-10-10S	-10	-10	7/8-20	-	40	25		
54748-12-10S	-12	-10	1 1/4-18	-	45	25		
54771-06-06S	-6	-6	5/8-18	-	50	62/42		180° elbow
54771-08-08S	-8	-8	3/4-16	-	60	62/45		
54771-10-10S	-10	-10	7/8-14	-	70	80/60		
54771-12-12S	-12	-12	1 1/16-14	-	80	95/60		
54771-12-14S	-12	-14	1 1/16-14	-	80	98/60		

# Hose Fittings

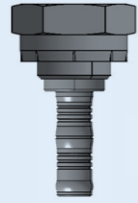
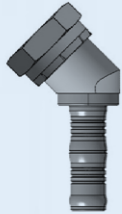
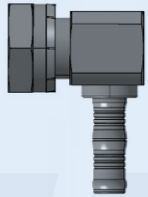

Description		Part No.	Fitting connection	Hose size	Thread	Valve	D	R
Straight		54707-10-08S	-10	-8	1-14	-	-	15
		54707-10-10S	-10	-10	1-14	-	-	15
		54707-10-12S	-10	-12	1-14	-	-	15
45° elbow		54708-10-08S	-10	-8	1-14	-	16	8
		54708-10-10S	-10	-10	1-14	-	16	8
		54708-10-12S	-10	-12	1-14	-	16	8
90° elbow		54709-10-08S	-10	-8	1-14	-	18	15
		54709-10-10S	-10	-10	1-14	-	18	15
		54709-10-12S	-10	-12	1-14	-	18	15

# Hose Fittings

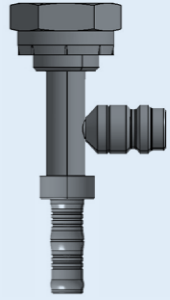
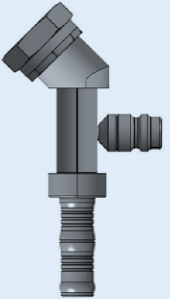
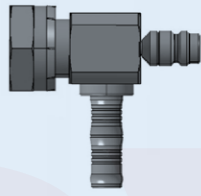

Part No.	Fitting connection	Hose size	Thread	Valve	D	R		Description
54733-10-08HPS	-10	-8	1-14	16 (HP)	-	58		Straight
54733-10-10HPS	-10	-10	1-14	16 (HP)	-	58		
54733-10-10LPS	-10	-10	1-14	13 (LP)	-	58		
54733-10-12LPS	-10	-12	1-14	13 (LP)	-	58		
54734-10-08HPS	-10	-8	1-14	16 (HP)	16	58		45° elbow
54734-10-10HPS	-10	-10	1-14	16 (HP)	16	58		
54734-10-10LPS	-10	-10	1-14	13 (LP)	16	58		
54734-10-12LPS	-10	-12	1-14	13 (LP)	16	58		
54735-10-08HPS	-10	-8	1-14	16 (HP)	18	15		90° elbow
54735-10-10HPS	-10	-10	1-14	16 (HP)	18	15		
54735-10-10LPS	-10	-10	1-14	13 (LP)	18	15		
54735-10-12LPS	-10	-12	1-14	13 (LP)	18	15		

Tube-O compressor fitting

Tube-O compressor fitting with R134a valve

# Hose Fittings

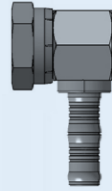
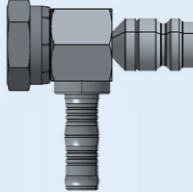
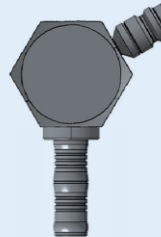
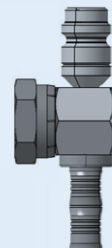
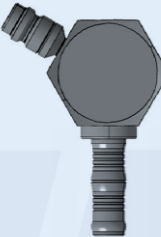

Description		Part No.	Fitting connection	Hose size	Thread	Valve	D	R
90° elbow		54450-10-08S	-10	-8	1-14	-	18	18
		54450-10-10S	-10	-10	1-14	-	18	18
		54450-10-12S	-10	-12	1-14	-	18	18
90° elbow with R134a valve - top		54451-10-08HPS	-10	-8	1-14	16 (HP)	18	18
		54451-10-10LPS	-10	-10	1-14	13 (LP)	18	18
		54451-10-12LPS	-10	-12	1-14	13 (LP)	18	18
90° elbow with R134a valve - 120°		54453-10-08HPS	-10	-8	1-14	16 (HP)	18	18
		54453-10-10LPS	-10	-10	1-14	13 (LP)	18	18
		54453-10-12LPS	-10	-12	1-14	13 (LP)	18	18
90° elbow with R134a valve - forward		54454-10-08HPS	-10	-8	1-14	16 (HP)	18	18
		54454-10-10LPS	-10	-10	1-14	13 (LP)	18	18
		54454-10-12LPS	-10	-12	1-14	13 (LP)	18	18
90° elbow with R134a valve - 240°		54455-10-08HPS	-10	-8	1-14	16 (HP)	18	18
		54455-10-10LPS	-10	-10	1-14	13 (LP)	18	18
		54455-10-12LPS	-10	-12	1-14	13 (LP)	18	18

# Hose Fittings

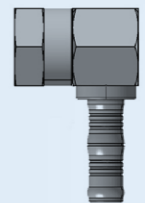
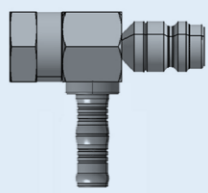
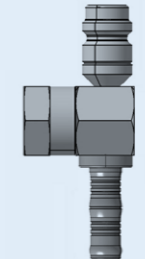
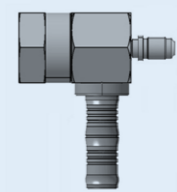

Part No.	Fitting connection	Hose size	Thread	Valve	D	R		Description
54425-06-06S	-6	-6	5/8-18	-	13	13		90° elbow
54425-08-08S	-8	-8	3/4-16	-	16	14		
54425-10-10S	-10	-10	7/8-14	-	16	16		
54426-06-06HPS	-6	-6	5/8-18	16 (HP)	13	13		90° elbow with R134a valve - top
54426-08-08HPS	-8	-8	3/4-16	16 (HP)	16	14		
54426-10-10LPS	-10	-10	7/8-14	13 (LP)	16	16		
54427-06-06HPS	-6	-6	5/8-18	16 (HP)	13	13		90° elbow with R134a valve - forward
54427-08-08HPS	-8	-8	3/4-16	16 (HP)	16	14		
54427-10-10LPS	-10	-10	7/8-14	13 (LP)	16	16		
54428-06-06S	-6	-6	5/8-18	7/16-20	13	13		90° elbow with 7/16-20 valve - top
54428-08-08S	-8	-8	3/4-16	7/16-20	16	14		
54428-10-10S	-10	-10	7/8-14	7/16-20	16	16		



Tube-O Hex block 90°

Female O-Ring HEX block 90°



# Hose Fittings

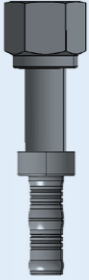
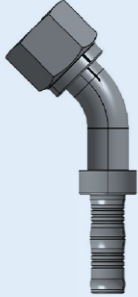

Description		Part No.	Fitting connection	Hose size	Thread	Valve	D	R
Straight		54501-04-06S	-4	-6	9/16-18	-	-	10
		54501-06-06S	-6	-6	11/16-16	-	-	10
		54501-08-08S	-8	-8	13/16-16	-	-	12
		54501-08-10S	-8	-10	13/16-16	-	-	12
		54501-10-10S	-10	-10	1-14	-	-	15
		54501-12-12S	-12	-12	1 3/16-12	-	-	15
45° elbow		54502-04-06S	-4	-6	9/16-18	-	15	45
		54502-06-06S	-6	-6	11/16-16	-	15	45
		54502-06-08S	-6	-8	11/16-16	-	15	45
		54502-08-08S	-8	-8	13/16-16	-	15	52
		54502-10-10S	-10	-10	1-14	-	17	55
		54502-10-12S	-10	-12	1-14	-	17	55
		54502-12-12S	-12	-12	1 3/16-12	-	25	75
90° elbow		54503-04-06S	-4	-6	9/16-18	-	30	40
		54503-06-06S	-6	-6	11/16-16	-	30	40
		54503-06-08S	-6	-8	11/16-16	-	30	40
		54503-08-06S	-8	-6	13/16-16	-	30	40
		54503-08-08S	-8	-8	13/16-16	-	35	50
		54503-08-10S	-8	-10	13/16-16	-	35	50
		54503-10-08S	-10	-8	1-14	-	40	50
		54503-10-10S	-10	-10	1-14	-	40	50
		54503-10-12S	-10	-10	1-14	-	40	50
		54503-12-12S	-12	-12	1 3/16-12	-	50	60
		54503-14-14S	-14	-14	1 5/16-12	-	55	65
		54503-16-14S	-16	-14	1 7/16-12	-	60	70

# Hose Fittings

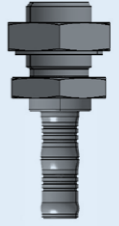
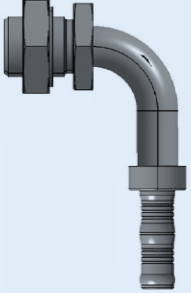
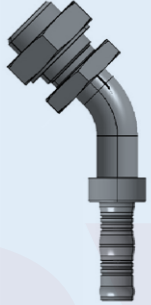

Part No.	Fitting connection	Hose size	Thread	Valve	D	R		Description
54758-06-06S	-6	-6	5/8-18	-	-	12		Straight
54758-08-08S	-8	-8	3/4-16	-	-	12		
54758-10-10S	-10	-10	7/8-14	-	-	12		
54758-12-12S	-12	-12	1 1/16-14	-	-	12		
54759-06-06S	-6	-6	5/8-18	-	30	52		90° elbow
54759-08-08S	-8	-8	3/4-16	-	40	52		
54759-10-10S	-10	-10	7/8-14	-	50	52		
54759-12-12S	-12	-12	1 1/16-14	-	52	65		
54760-06-06S	-6	-6	5/8-18	-	25	82		45° elbow
54760-08-08S	-8	-8	3/4-16	-	28	95		
54760-10-10S	-10	-10	7/8-14	-	25	97		
54760-12-12S	-12	-12	1 1/16-14	-	30	100		

ORFS Female swivel

Male Insert O-Ring Bulkhead

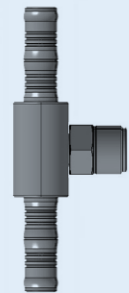
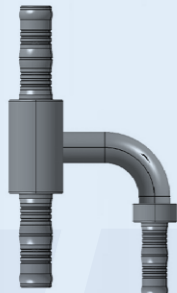
Description		Part No.	Fitting connection	Hose size	Thread	Valve	D	R
In-line splicer		548753-06-06S	-	-6	-	-	-	25
		548753-08-08S	-	-8	-	-	-	25
		548753-10-10S	-	-10	-	-	-	25
		548753-12-12S	-	-12	-	-	-	25
In-line splicer with O-Ring insert		548760-10-10-08S	-	-10/-8	3/4 - 16	-	-	25
In-line splicer 90° elbow		548761-10-10-06S	-	-10/-6	-	-	45	25
		548761-10-10-12S	-	-12	-	-	60	25

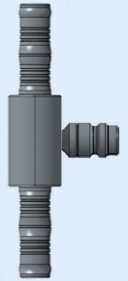
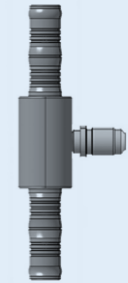
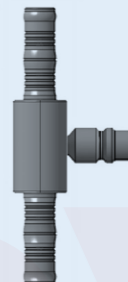
Part No.	Fitting connection	Hose size	Thread	Valve	D	R		Description
548751-06-06HP	-	-6	-	16 (HP)	-	25		with R134a valve
548751-08-08HP	-	-8	-	16 (HP)	-	25		
548751-10-10HP	-	-10	-	16 (HP)	-	25		
548751-10-10LP	-	-10	-	13 (LP)	-	25		
548751-12-12HP	-	-12	-	16 (HP)	-	25		
548751-12-12LP	-	-12	-	13 (LP)	-	25		
548751-14-14LP	-	-14	-	13 (LP)	-	25		
548754 -06-06S	-	-6	-	7/16-20	-	25		with MF 7/16" valve
548754 -08-08S	-	-8	-	7/16-20	-	25		
548754 -10-10S	-	-10	-	7/16-20	-	25		
548754 -12-12S	-	-12	-	7/16-20	-	25		
547999 -06-06HPS	-	-6	-	17 (HP)	-	25		with R1234yf valve
547999 -08-08HPS	-	-8	-	17 (HP)	-	25		
547999 -10-10LPS	-	-10	-	14 (LP)	-	25		
547999 -12-12LPS	-	-12	-	14 (LP)	-	25		

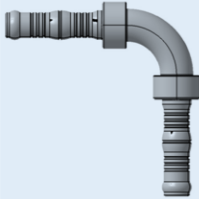
Description		Part No.	Fitting connection	Hose size	Thread	Valve	D	R
In-line splicer 90°		548749-06-06S	-	-6	-	-	35	35
		548749-08-08S	-	-8	-	-	42	42
		548749-10-10S	-	-10	-	-	45	45
		548749-12-12S	-	-12	-	-	51	51

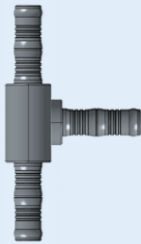
In-line splicer T		548750-06-06-06S	-	-6	-	-	-	25
		548750-08-06-06S	-	-8/-6	-	-	-	25
		548750-08-08-08S	-	-8	-	-	-	25
		548750-10-08-08S	-	-10/-8	-	-	-	25
		548750-10-10-08S	-	-10/-8	-	-	-	25
		548750-10-10-10S	-	-10	-	-	-	25
		548750-12-10-08S	-	-12/-10/-8	-	-	-	25
		548750-12-10-10S	-	-12/-10	-	-	-	25
		548750-12-12-12S	-	-12	-	-	-	25
		548750-14-14-14S	-	-14	-	-	-	25

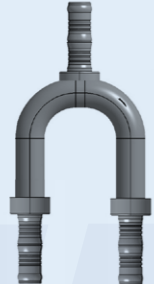
In-line splicer Y		548752-06-06-06S	-	-6	-	-	55	60
		548752-08-08-08S	-	-8	-	-	62	70
		548752-10-10-10S	-	-10	-	-	67	75
		548752-12-12-12S	-	-12	-	-	75	90

Part No.	Fitting connection	Hose size	Thread	Valve	D	R		Description
54743-06-06S	-6	-6	-	-	-	-		Straight steel
54743-06-08S	-6	-8	-	-	-	-		
54743-08-08S	-8	-8	-	-	-	-		
54743-08-10S	-8	-10	-	-	-	-		
54743-10-10S	-10	-10	-	-	-	-		
54743-10-12S	-10	-12	-	-	-	-		
54743-12-10S	-12	-10	-	-	-	-		
54743-12-12S	-12	-12	-	-	-	-		
54743-12-14S	-12	-14	-	-	-	-		
54743-14-14S	-14	-14	-	-	-	-		
54743-16-14S	-16	-14	-	-	-	-		





Straight aluminium		54743-06-06A	-6	-6	-	-	-	-
		54743-08-08A	-8	-8	-	-	-	-
		54743-10-10A	-10	-10	-	-	-	-
		54743-12-12A	-12	-12	-	-	-	-
		54743-12-14A	-12	-14	-	-	-	-



# Hose Fittings

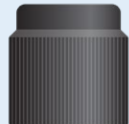

Service valve caps and cores

Description		Part No.
Burgaclick valve cap - 7/16		7042
Burgaclick valve cap - HP 16mm		7037
Burgaclick valve cap - LP 13mm		7038
Burgaclick valve core R134a		7039



HNBR O-Rings

Description		Part No.	Proposed torque (Nm)	Width (mm)	I.D. (mm)
HNBR O-Rings		7028-04	-	4.47	1.78
		7028-06	13.60 - 20.30	1.78	7.65
		7028-08	32.50 - 42.00	1.78	10.82
		7028-10	35.30 - 42.00	1.78	14.00
		7028-12	40.70 - 47.50	1.78	17.17

# Hose Fittings

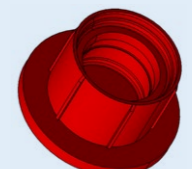
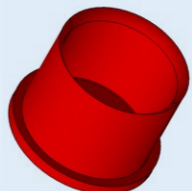

Fitting caps

Part No.		Description
10133-04		Male cap
10133-06		
10133-08		
10133-10		
10133-12		
10134-06		Female cap
10134-08		
10134-10		
10134-12		
8766		Clip pliers
8767		Hose cutters

Tools









## **Burgaflex BV Holland**

Mon Plaisir 112  
4879 AT Etten-Leur  
Phone: +31 (0) 76 503 5000  
Email info@burgaflex.nl



## **Burgaflex UK Ltd.**

Unit 1.03 Phoenix Park Industrial Estate  
Phoenix Close  
Heywood, Lancs. OL10 2JG  
Phone: +44 (0) 1706 620 220  
Email: info@burgaflex.co.uk



## **Burgaflex Turkey Ltd.**

Orta Olcekli San. Sit., 14.Sokak No. 10  
Muradiye Mah., Yunusemre 45140  
Manisa Turkey  
Phone: +90 (0) 236 2140520 - 21  
E-mai: info@burgaflex.com.tr



## **Burgaflex Poland Sp. z o.o.**

ul. Rzemieslnicza 6  
42-504 Bedzin  
Phone: +48 32 291 40 04  
Email: info@burgaflex.pl



## **Burgaflex France SAS**

Z.A. De Perriers, 82-84 Route de Cor  
78505 SARTROUVILLE CEDEDmeilles  
Phone: +33 (0) 1 3962 83 67  
Email: info@burgaflex.fr



## **Burgaflex Asia Pacific**

14 Motorway Circuit  
Ormeau, Queensland 4208  
Phone: +61 (0) 7 5549 4022  
Email: info@burgaflex.com.au



## **Burgaflex China Limited**

Unit 1109, 11/F, Manhattan Center  
8 Kwai Cheong Road, Kwai Chung, N.T.  
Hong Kong  
Phone: +852 (0) 2422 0180