



Unicla



A Series

UP90 UP120 UP150 UP170

**Compressor
Service Manual**

A Group Compressor Service Manual

Table of contents:

1. Specifications

UP90/UP120/UP150/UP170	1
Magnetic clutch	2
Rear cap	2

2. Component part list

I. Compressor part numbers	3
II. Exploded view	4

3. Service

Service tools part numbers	5
Bolt torque specifications	5
Service tools	6
Removal of clutch assembly	7
Magnetic clutch installation	8
Removal of lip seal	9
Installation of lip seal	9
Installation of lip seal continued	10
Disassembly of body	10
Disassembly of body continued	11
Assembly of body	11
Assembly of body continued	12
System oil quantity	13
Oil type and grade	13



Copyright ©2007 All rights reserved

No part of this document shall be reproduced in whole or in part without the permission of Unicla International Ltd. This includes reproduction or copies in any form or by any means including photocopying, printing or electronic media.

IMPORTANT DISCLAIMER

This is a guideline document containing professional information using representative graphs, charts and tables. Manufacturers' specifications must be consulted for specific guidelines and performance data. Unicla published data, specific to all models, is available in promotional literature and from Unicla International Ltd on request or through your Unicla supplier. Unicla International Ltd expressly disclaims all and any liability and responsibility to any person or business as a result of any actions taken on the basis of information in this publication.

Specifications

UP-90

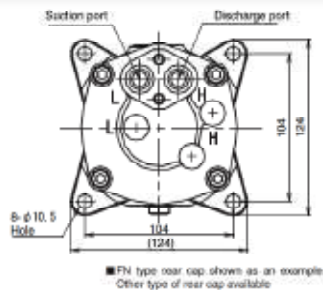
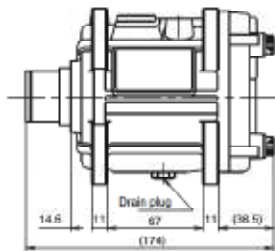

Compressor Model	UP-90
Number of cylinders	10
Displacement	92 cc/rev
Refrigerant	HFC-134a
Initial oil charge	140 cc
Oil type	Unidap 7 (PAG oil)
Weight without clutch	3.7 kg

UP-120

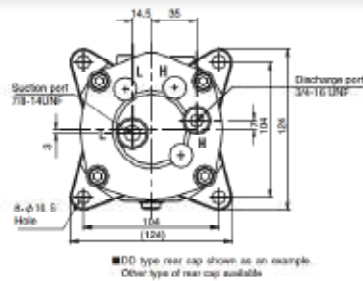
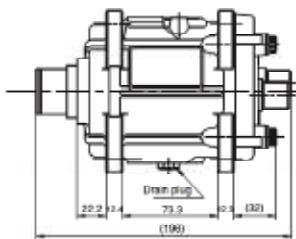

Compressor Model	UP-120
Number of cylinders	10
Displacement	119 cc/rev
Refrigerant	HFC-134a
Initial oil charge	140 cc
Oil type	Unidap 7 (PAG oil)
Weight without clutch	4.3 kg

UP-150

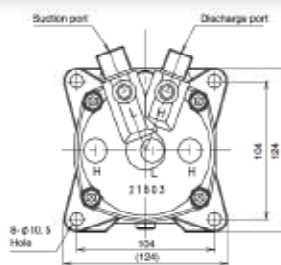
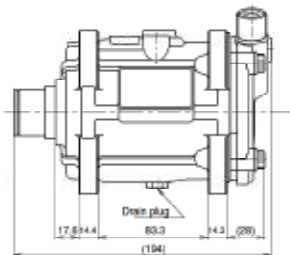

Compressor Model	UP-150
Number of cylinders	10
Displacement	145 cc/rev
Refrigerant	HFC-134a
Initial oil charge	160 cc
Oil type	Unidap 7 (PAG oil)
Weight without clutch	4.8 kg

UP-170

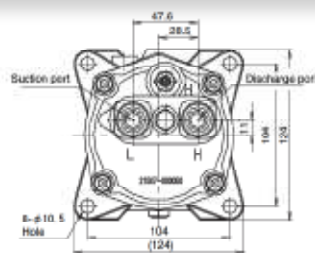
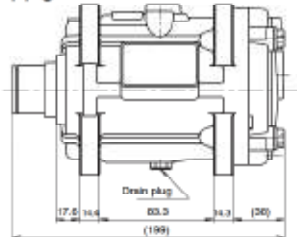

Compressor Model	UP-170
Number of cylinders	10
Displacement	172 cc/rev
Refrigerant	HFC-134a
Initial oil charge	160 cc
Oil type	Unidap 7 (PAG oil)
Weight without clutch	4.9 kg









Magnetic clutch

Clutches available for Unicla A series compressors - pulley diameter (mm) and voltage

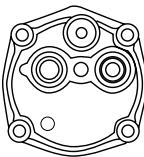
Type	119	120	125	130	132	133	135	137	140	141	145	150	152	12V	24V
A Groove			•				•				•		•	•	•
AA Groove			•		•		•				•			•	•
B Groove							•	•						•	•
BB Groove				•			•		•					•	•
4 Groove			•				•		•	•				•	•
5 Groove	•						•				•	•		•	•
6 Groove		•	•				•		•					•	•
8 Groove	•													•	•
10 Groove			•											•	•

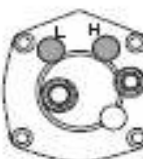
Rear cap for UP90, 120, 150, 170

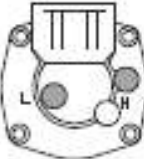
Rear caps and hose ports available for Unicla A series compressors

Cap type	U	DD	FN	
Hose port	O ring	O ring	Flange	
No charging ports	 U01	 DO1	 FN1	 FN8
With charging ports	 U02	 DO2	 FN2	 FN6
With charging ports	 U03	<ol style="list-style-type: none"> 1. U = Vertical Hose Ports 2. D = Horizontal Hose Ports 3. FN = Flange Hose Ports 4. Relief valve is also available on the cap 5. Use the type no's shown in each box when selecting compressor model 		

Compressor parts

Item	Description	UP90	UP120	UP150	UP170	Qty
1	Body	21404-000690	21404-000700	21404-000102	21404-000092	1
2	Working assy	22010-000250	22010-000240	22010-000220	22010-000230	1
3	Suction valve plate	22602-000120	←	←	←	2
4	Front valve plate	22601-000052	←	←	←	1
5	Rear valve plate	↑	←	←	←	1
6	Front gasket	93204-000060	←	←	←	1
7	Rear gasket	↑	←	←	←	1
8	Lip seal assy	93503-000040	←	←	←	1
8-1	Snap ring	92503-000040B				
8-2	Lip seal	92503-000040A				
9	Felt seal	11950-10400	←	←	←	1
10	Felt ring	11961-10400	←	←	←	1
11	Plug	13201-000010	←	←	←	1
12	O ring	92501-000120	←	←	←	3
13	O ring	92501-000330	←	←	←	1
14	Rear cap	see page 2	←	←	←	1
15	Charge Valve assy (H)	38101-000030	←	←	←	1
16	Charge Valve assy (L)	38101-000020	←	←	←	1
17	H Cap	12901-000030	←	←	←	1
18	L Cap	12901-000020	←	←	←	1
19	Relief valve	38305-000030	←	←	←	1
20	O ring	92501-000060	←	←	←	1
21	Bolt	91915-08035	←	←	←	4

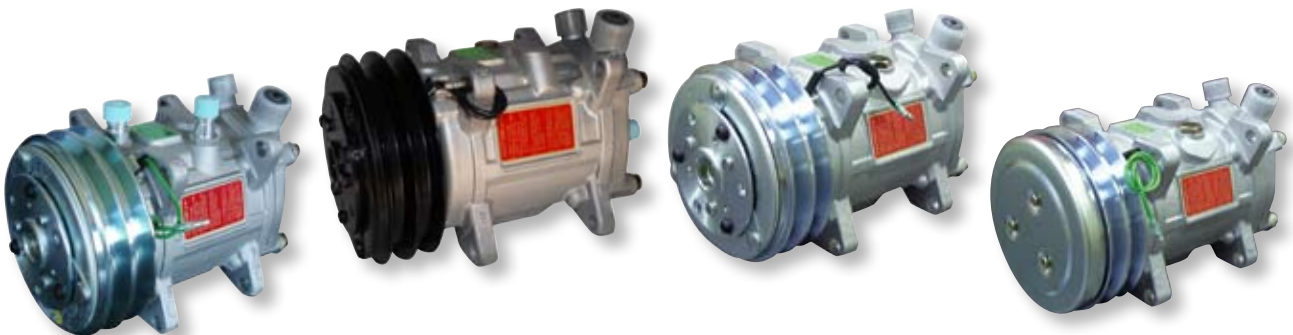

Exploded view

A SERIES

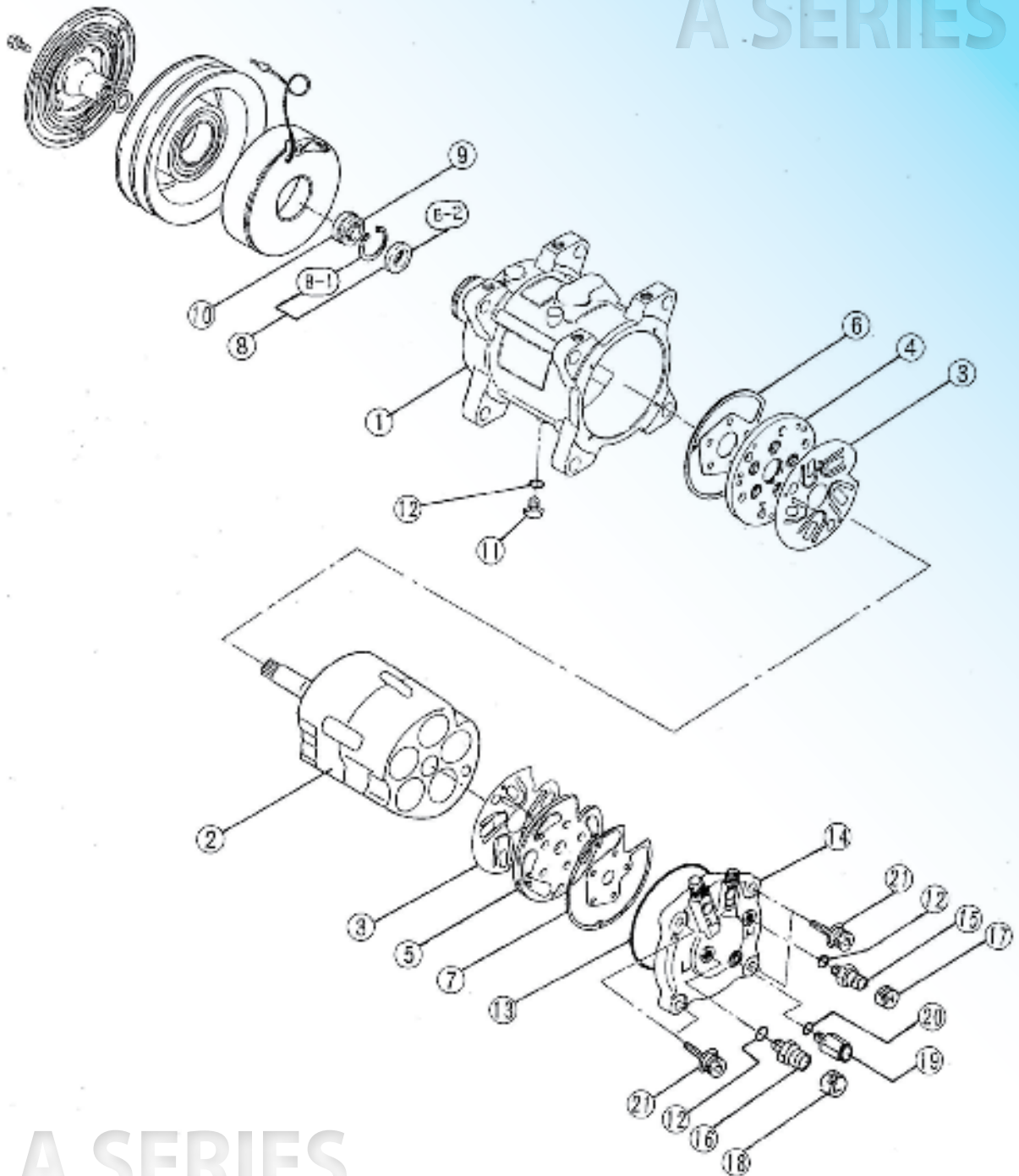

A SERIES

Service tool part numbers

No.	Description	Part number
1	Working assembly bench	03301- 00084A
2	Stand, rear mount	03301- 001170
3	Stand, front	03301- 00914A
4	Hub remover, clutch	03301- 000570
5	Pulley pad	03301- 010050
6	Remover, lip seal	03301- 001120
7	Installer, lip seal	03301- 000600
8	Shaft rotating handle	03301- 000610
9	Guide pin	03301- 000360
10	Guide sleeve	03301- 000620
11	Installer, pulley	03301- 000630
12	Socket, 10mm	03301- 000640
13	Socket, 6mm Hex	03301- 000650
14	Clutch wrench	03301- 000660
15	Torque wrench	03301- 000380
16	Snap ring pliers (<i>Shaft</i>)	03301- 000430
17	Snap ring pliers (<i>Hole</i>)	03301- 000420
18	Remover, pulley	03301- 000410
19	Plastic hammer	03301- 000390
20	Thickness guage	03301- 000400

Bolt torque specifications

Description	Bolt diameter (mm)	Tightening torque (N·m)
Housing cap bolts	M8	14.7 ± 1
High/low service valve	M12	11.7 ± 1
Blind plugs	M12	11.7 ± 1
Clutch armature bolts	M6	13.7 ± 1

Service tools

 - *Genuine Unicla tools*

 - *Optional generic tools*

1 03301-00084A

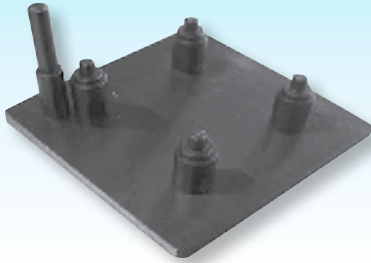

2 03301-001170

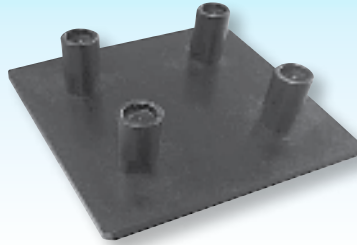

3 03301-00914A



4 03301-000570

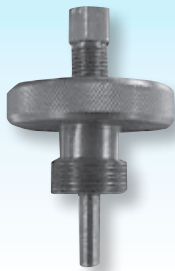

5 03301-010050

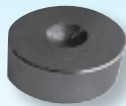

6 03301-001120



7 03301-000600



8 03301-000610



9 03301-000360



10 03301-000620



11 03301-000630



12 03301-000640



13 03301-000650



14 03301-000660

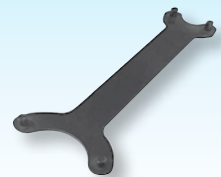

15 03301-000380



16 03301-000430



17 03301-000420



18 03301-000410



19 03301-000390



20 03301-000400



Removal of clutch assembly

I. Removal of fixing screw on armature

Tools required: • Stand • Clutch wrench
• Wrench • 10mm Socket

Procedure: Place the compressor on the stand. Hold clutch by inserting the claws of the clutch wrench into the holes on the armature. Remove the centre bolt by using the wrench.

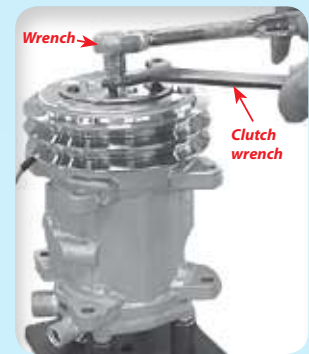

II. Removal of armature

Tools required: • Hub remover • Wrench

Procedure: Pull the armature upwards.



III. Removal of snap ring

Tools required: • Snap ring pliers (*shaft*)

Procedure: Remove the snap ring with the snap ring pliers.



IV. Removal of pulley assembly

Tools required: • Remover, pulley • Wrench • Pulley pad

Procedure: Remove the pulley assembly with the remover.

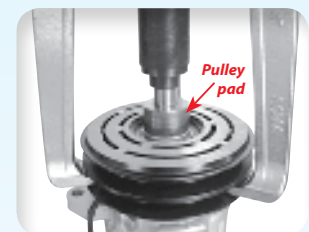

V. Removal of coil (3 bolt type)

Tools required: • Standard screwdriver

Procedure: Remove 3 M5 bolts with screwdriver.



Removal of coil (snap ring type)

Tools required: • Snap ring pliers (*shaft*)

Procedure: Remove the snap ring with pliers as shown.



VI. Inspection of clutch components

1. Armature - Contact surface must be clean, smooth and unmarked, with no abnormal scoring.

2. Pulley - Contact surface must be clean, smooth and unmarked, with no abnormal scoring.

3. Coil - Wiring harness must be in good condition.



Armature



Pulley



Coil

Magnetic clutch installation

I. Installation of coil (3 bolt type)

Tools required: • Stand • Standard screwdriver

Procedure: Tighten 3 M5 bolts (*wire must be visible at 3 o'clock position, when viewed from the front*).

Tightening torque: $4.9 \pm 1 \text{ N}\cdot\text{m}$

Installation of coil (snap ring type)

Tools required: • Stand • Snap ring pliers (*shaft*)

Procedure: Install the snap ring into the groove.

II. Installation of pulley

Tools required: • Pulley installer • Plastic hammer

Procedure: Place the pulley on the nose top and install it by tapping on the installer until it stops. Do not tap if the pulley is not located correctly.

III. Installation of clutch snap ring

Tools required: • Snap ring pliers (*shaft*)

Procedure: Install the snap ring into groove (*tapered side up*).

IV. Installation of shims and armature

Tools required: • Guide pin

Procedure: Install the guide pin into the centre threaded hole of the shaft and select shims ($T=0.1, 0.3 \text{ and } 0.5\text{mm}$) to ensure the clutch clearance as in figure.

V. Installation of armature

Tools required: • Clutch wrench • Torque wrench
• 10mm Socket

Procedure: Install the M6 bolt by holding the clutch wrench on the holes (*3 positions*) on the armature.

Tightening torque: $13.7 \pm 1 \text{ N}\cdot\text{m}$

VI. Air gap

Tools required: • Thickness gauge

Procedure: Ensure clutch clearance is correct all around.
($0.3\text{mm} \leq \text{Gap} \leq 0.6\text{mm}$)

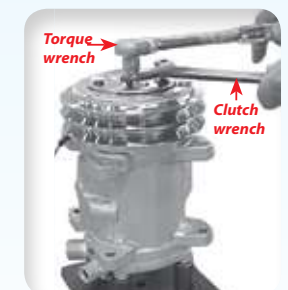
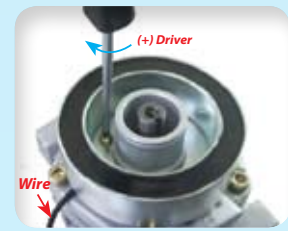

Removal of lip seal

I. Removal of the felt ring

Tools required: • Lipseal remover

Procedure: Insert the remover into the recess of the felt seal and turn around lightly and pull. Remove the felt on the shaft by hooking with the needle tool.

II. Removal of snap ring

Tools required: • Snap ring pliers (*hole*)

Procedure: Remove the snap ring slowly with pliers as shown in the figure.

III. Removal of lip seal

Tools required: • Lipseal remover

Procedure: Insert the remover into the recess of the seal and turn around lightly and pull.

IV. Inspection of lip seal

1. **Felt seal** - *should be dry.*
2. **Snap ring** - *must be in one piece and not deformed.*
3. **Lip seal** - *contact surface must be clean, smooth and unmarked with no abnormal scoring.*

Installation of lip seal

I. Setting the guide sleeve

Tools required: • Stand • Guide sleeve • Seal installer

Procedure: Place compressor on the stand. Lubricate outside of the guide sleeve and insert into the shaft of the compressor.

Caution - the sleeve must be clean and unmarked.

II. Installation of lip seal

Tools required: • Guide sleeve • Seal installer

Procedure: Slide the lipseal over the guide sleeve. Place the installer on the lip seal correctly and press the lipseal with the installer until it stops. Then remove the guide sleeve.

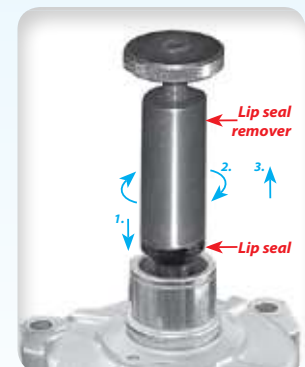
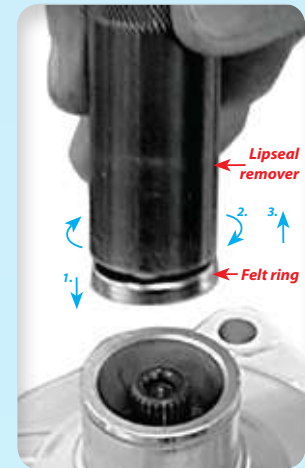

Installation of lip seal - *continued*

III. Assembly of the snap ring

Tools required: • Snap ring pliers (*hole*) • Seal installer

Procedure: Insert the snap ring into nose section (*tapered part of the snap ring must be facing downwards*). Push the snap ring downward with the installer, and fit into the groove.

IV. Assembly of the felt seal

Tools required: • Installer seal

Procedure: Install the felt seal into the nose section. Push the felt seal until it touches the snap ring.



Disassembly of the body

Caution - O-ring should not be reused.

I. Removal of oil

Procedure: Remove the drain plug and drain the oil.

II. Removal of lipseal (*Refer to page 9 for instructions*)

III. Removal of the bolts on rear cap

Tools required: • Socket wrench • Socket 6mm hex • Stand

Procedure: Remove the M8 securing bolts (*4pcs*) from the rear cap.

IV. Removal of the rear cap

Procedure: Remove the rear cap by gently inserting a screw driver or lever into the recess. Lever all around, not just at one position.

Caution - Do not damage the cap or body.



Disassembly of the body - *continued*

V. Removal of rear valve

Procedure: Remove gasket, valve plate and suction valve.

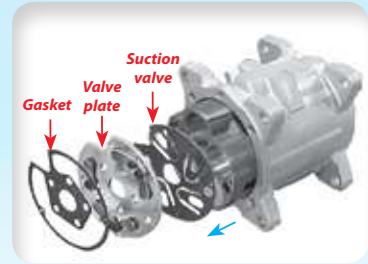

VI. Removal of front valve and working assembly

Procedure: Remove the working assembly by pressing the end of the shaft into the front of the body as shown. After removal of the cylinder, remove gasket, valve plate and suction valve from the front side.

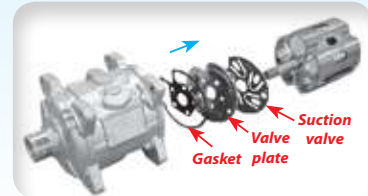

Assembly of the body

I. Installation of the O-ring for rear cap

Procedure: The o-ring must be free from marks and dust. Thoroughly lubricate new o-ring properly and insert into the groove. Ensure the o-ring is lying straight in the groove without a twist.



II. Installation of rear valve plate and working assembly

Tools required: • Working assembly bench

Procedure: Stack suction plate, valve plate and gasket on locating pins of rear cap in sequence as shown in the figure. Place the working assembly on rear cap.

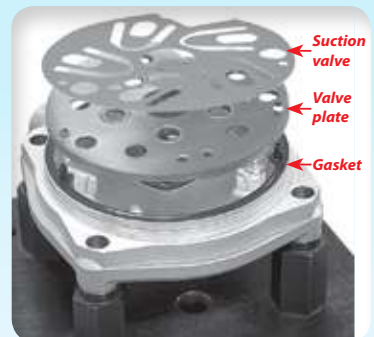

III. Installation of front valve plate and body

Tools required: • Working assembly bench

Procedure: Stack suction plate, valve plate and gasket on locating pins of working assembly. Slide body over working assembly until it stops on the working bench guide.



Assembly of the body - continued

IV. Inspection, tightening and clearance of the rear cap

Tools required: • Torque wrench • Hexagon socket 6mm
• Thickness guage

Procedure: Tension the M8 Hexagonal flange bolts (4pcs) diagonally, alternately and carefully. Check the rear cap clearance as specified: $0.2 \leq \text{Gap} \leq 0.6\text{mm}$

Tightening torque: $14.7 \pm 1 \text{ N}\cdot\text{m}$

V. Installation of lipseal (Refer to page 9 for instructions)

VI. Test working assembly rotation

Tools required: • Shaft rotating handle

Procedure: Install the handle into the front section to check the shaft rotates smoothly.

VII. Filling compressor oil

Procedure: Fill the following amount of oil into the drain hole as shown in the photo. Ensure drain is correctly plugged.

Standard oil type: Unidap 7 (PAG) or Unidap 3 (POE)

Amount of oil:

UP150/170 = $160 \pm 10 \text{ cc}$

UP90/120 = $140 \pm 10 \text{ cc}$

VIII. Drain plug

Procedure: Tighten drain plug.

Tightening torque: $11.7 \pm 1 \text{ N}\cdot\text{m}$

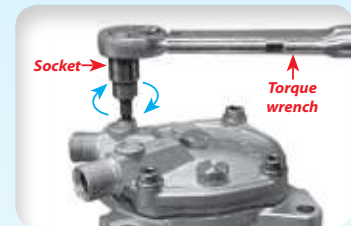
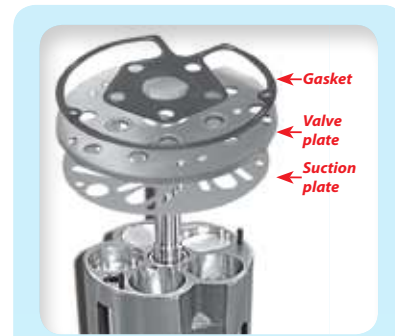

System oil quantity

The correct amount of oil must be maintained in the compressor and system. Long hose runs and dual evaporator systems must have additional oil added to the system. Severe oil starvation problems may result from insufficient system oil being allowed. To determine oil quantity required, Unicla recommends a calculation as a percentage of refrigerant charge as follows:

- **20% for all A-group compressors (90-170cc)** in standard applications where the suction and discharge lines are less than 6 metres in length.
- **30% for all A-group compressors (90-170cc)** in applications where suction and discharge lines exceed 6m in length.

Example: Calculate oil charge as 20% of refrigerant charge, 2 kg charge = 2000 g x 20% = 400 ml (cc) of oil. If fitting a UP/UX170 compressor, then deduct the compressor initial oil charge to determine amount of oil to be added. Therefore 400 – 160 = 240cc oil to be added to system.

Oil type and grade

Each Unicla A-Group compressor is fitted with either PAG oil (*Unidap 7*) or POE oil (*Unidap 3 is fitted to F-series compressors*). When adding oil to the system, Unicla oil must be used.

⚠ Warranty is void if these guidelines are not followed.

Compressor Model	Refrigerant	Oil Type (Unicla)	Viscosity @ 40°C	Viscosity @ 100°C	Application	Low side Saturation	Oil Separator
UP/UX 90/120/150/170	R134a	Unidap 7	48.01	10.51	Airconditioning	> 0°C	Optional
UPF 90/120/150/170	R404a	Unidap 3	32.5	5.8	Airconditioning	>15°C	Required

The following labels will determine the type of oil in each A-group or F-series compressor:



POE type
(fitted to F-series compressors)



PAG type

Storage guidelines

- Evacuate compressor for 3 minutes and fill with nitrogen (N₂) at 0.1 ~ 0.2 MPa.
- Place the compressor in a clean and dry area with low humidity and tag with details.
- Keep compressor away from direct sunlight.
- Store the compressor horizontally on a flat, even surface.
- Do not store the compressor in temperatures above 30°C.
- Place the compressor in a well ventilated area to avoid corrosion damage.

*The contents of this manual are subject to change without prior notice.

Notes:

Lined writing area consisting of multiple horizontal blue lines.



Unicla International Limited
Unit 1209-1210, 12F Manhattan Centre,
8 Kwai Cheong Rd, Kwai Chung, N.T.,
Hong Kong

Phone (852) 2422 0180
Fax (852) 2422 0680
Email: sales@unicla.hk
Website: www.unicla.hk